

 *Masonite*
the beautiful door™

steel & fiberglass
**entry
doors**

2009

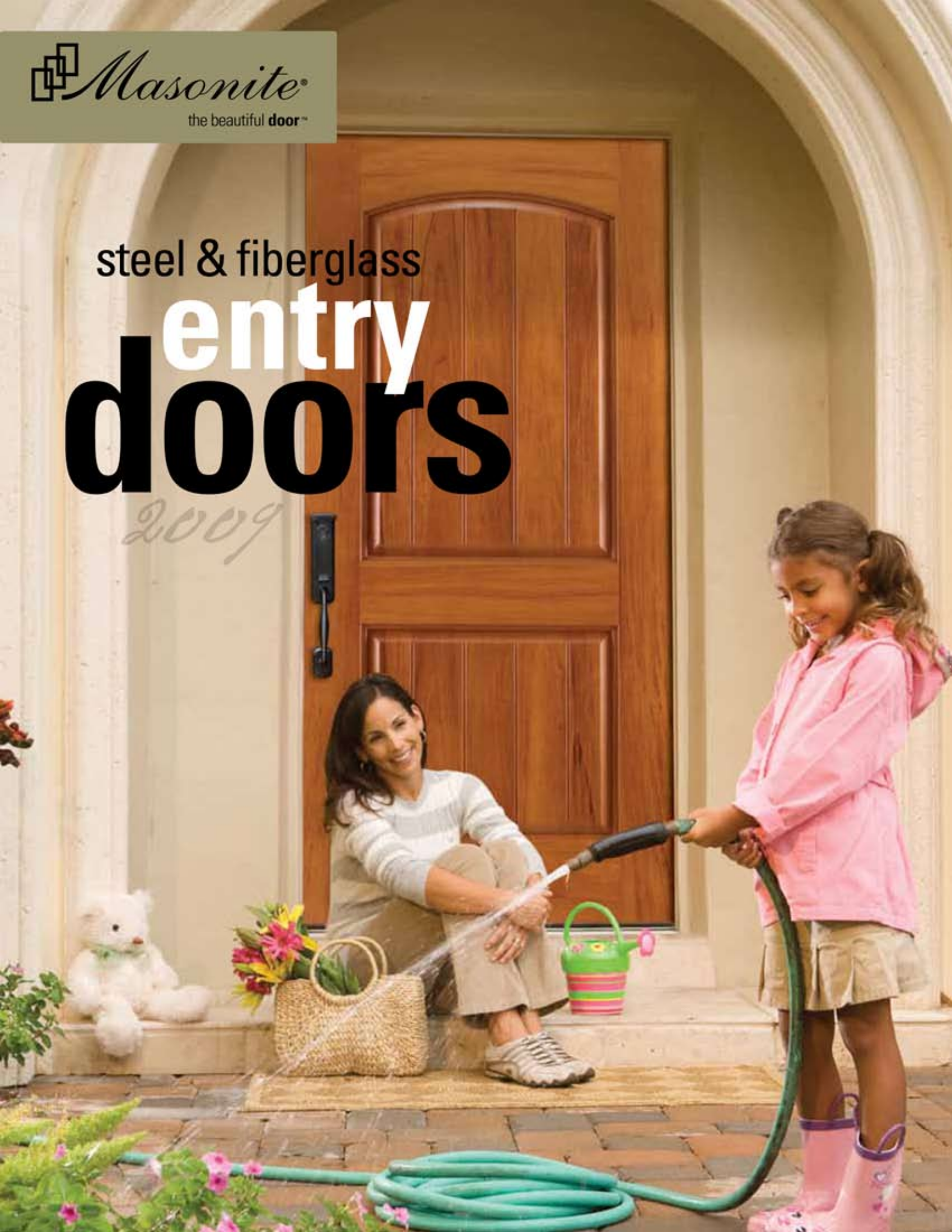



get more

MASONITE® STEEL & FIBERGLASS ENTRY SYSTEMS GIVE YOU MORE

Enhance your curb appeal and add value to your home with a Masonite entryway. Homeowners, architects and builders rely on Masonite for a comprehensive line of beautiful and durable fiberglass and steel entry doors.

This catalog features our extensive line of fiberglass and steel door products shown in a range of panel designs and glass configurations that are sure to meet your architectural style or design need. Make your entryway come to life when you experience our door designer at www.masonite.com.

Craftsmanship

BARRINGTON® CRAFTSMAN MAHOGANY TEXTURED BDM-225-SB1-3



MASONITE® HD STEEL MHD-2P

visit our web site and explore more solutions...

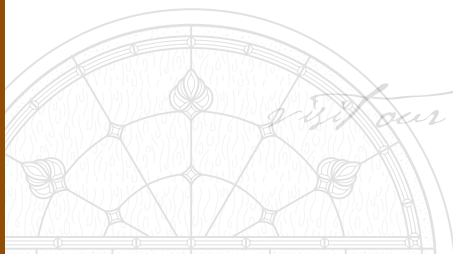



BARRINGTON® SIERRA™ SSP-2

more door designs
more glass styles
more value

BARRINGTON® FLAGSTAFF™ with AvantGuard™ Spanish Cedar finish BAC-P



BARRINGTON® MAHOGANY TEXTURED with BR1 glass BHM-303-BR1-2V

BARRINGTON® SIERRA™ with AvantGuard™ Black Walnut finish BAW-2B



BELLEVILLE® OAK TEXTURED with Monaco™ glass BLT-203-315-7

index

- Introduction 2
- Masonite® The Brand 4
- Get Inspired 6
- How to Choose Your Door 8
- Masonite's Full Line of Entry Doors 10
- Masonite® Fiberglass Door Collection
 - Barrington®
 - Traditional 12
 - Craftsman 16
 - Flagstaff™ 18
 - Sierra™ 18
 - AvantGuard™ Finish 20
 - Belleville®
 - Textured 22
 - Smooth 24
 - Oakcraft® 26
- Masonite® HD Steel Door Collection 28
- Specialty™ Glass 30
 - Internal Blinds 74
 - Venting Lites 74
 - Clear Glass 74
 - Flush-Glazed Doors 76
- Entry Systems 78
 - Entry Systems Handing 79
 - Entry Systems Rough Openings 80
- Masonite® Patio Door Systems 82
 - Patio Door Rough Openings 84
 - Patio Door Handing 85
- Fast-Frame™ 86
- Door Availability Charts 88
- Masonite® Stain Kit 95
- Glass Availability Charts 96



Our continuing program of product improvement makes specifications, design and product detail subject to change without notice. Also, due to limitations of the printing process, product images may not match exactly in color to actual product. Masonite reserves the right to make ongoing improvements and changes to existing designs.

BARRINGTON® SIERRA™ with AmGuard™ Spanish Cedar finish

2009



exceptional quality

Brands of Masonite's stature don't just happen. They come from years of dedication and a relentless commitment to improvement. That's why Masonite has one of the world's largest private research and development facilities in the door industry. Masonite owns hundreds of international patents, trademarks and applications.

Through a variety of strategic marketing initiatives, the Company is committed to growing the Masonite brand. Masonite believes that a strong brand will bring value to the products used in homes worldwide and increase the business of its customers. It is for these reasons that Masonite stands as one of the greatest brands within the building products industry.

THE MASONITE BRAND

Since 1925, the Masonite name has been known worldwide for its commitment to product innovation, manufacturing excellence and customer service. These qualities and values are as true today as they were more than 80 years ago.

Masonite is constantly expanding its diverse line of interior and exterior doors to meet any design or budget. By combining the long-standing spirit of innovation with customer-focused product development, Masonite continues to be the brand that builders, remodelers and homeowners rely on in their quest to create homes of distinction.

Today more than ever, Masonite is relentlessly focused on delivering product, service and design innovations that enhance beauty and functionality, creating greater value to our customers throughout the world.



April 6, 2005, Kohlberg Kravis Roberts & Co. acquires Masonite International Corporation.

2005.

Masonite acquires The Stanley Works residential entry door division.

2004.

Masonite's largest customer and one of the world's leading door manufacturers, Prendor, Inc., acquires Masonite Corporation from International Paper Company.

2001.

Masonite enters the door business as a component supplier to the door industry.

1972.

The John M. Coates Technical Center was built in 1960 as the Company recognized the importance of separating R&D from mill operations to focus on new product and process innovation.

1960.

Masonite's current parent company enters the door business.

1955.

Masonite goes public with common stock shares listed on the New York Stock Exchange.

1935.

The Company's name was changed to Masonite Corporation.

1928.

On September 1, 1925, the corporation was formed and named Mason Fibre Company.

1925.

Well known researcher and engineer – William H. Mason, changed building materials industry forever by inventing the way wood is used to form more effective building materials.

1924.

innovative

1924



get inspired

Find a door configuration that suits your style or change it up to make it perfectly yours. Search the following pages for inspiring designs or check-out our door designer at www.masonite.com.



unique designs reflecting style



- 1 Barrington® Flagstaff™
- 2 Barrington® Mahogany Textured BR2 glass
- 3 Barrington® Craftsman Mahogany Textured Clear glass
- 4 Barrington® Flagstaff™ AvantGuard™ Spanish Cedar finish
- 5 Barrington® Oak Textured BR2 glass
- 6 Barrington® Mahogany Textured BR3 glass
- 7 Barrington® Sierra™ AvantGuard™ Black Walnut finish
- 8 Barrington® Oak Textured BR1 glass
- 9 Barrington® Sierra™ AvantGuard™ Spanish Cedar finish
- 10 Barrington® Sierra™ plank

- 11 HD Steel Monaco™ glass
- 12 HD Steel Alston™ glass
- 13 HD Steel Patio with Mini-Blinds
- 14 HD Steel Aurora™ glass
- 15 HD Steel Sienna™ glass
- 16 HD Steel Rockland™ glass
- 17 HD Steel Element™ glass
- 18 HD Steel Naples™ glass sidelites

- 19 Belleville® Mahogany Textured Naples™ glass
- 20 Belleville® Oak Textured Zavalla™ glass
- 21 Belleville® Oak Textured Navarro™ glass
- 22 Belleville® Mahogany Textured Rockland™ glass
- 23 Belleville® Oak Textured Riviera™ door & sidelite glass, Woodbridge™ transom glass
- 24 Belleville® Smooth Madrid™ glass
- 25 Belleville® Smooth Victorian™ glass
- 26 Belleville® Smooth Quattro™ glass



Masonite makes choosing the perfect entrance for your home as easy as...

123

Explore, design and create the entryway of your dreams with our online door designer and view our vast selection of interior doors designed to complement our entry systems at www.masonite.com.

choosing is
easy as

123

your style

1 choose your style

Choose a Masonite entry door design to suit your taste and complement your home's architectural style. Select from our vast line of traditional, contemporary or modern designs – from 1 panel to 9 panel patterns with or without decorative glass elements. Get creative and design your own custom look by enhancing your door with beautiful matching glass, transoms and sidelites.

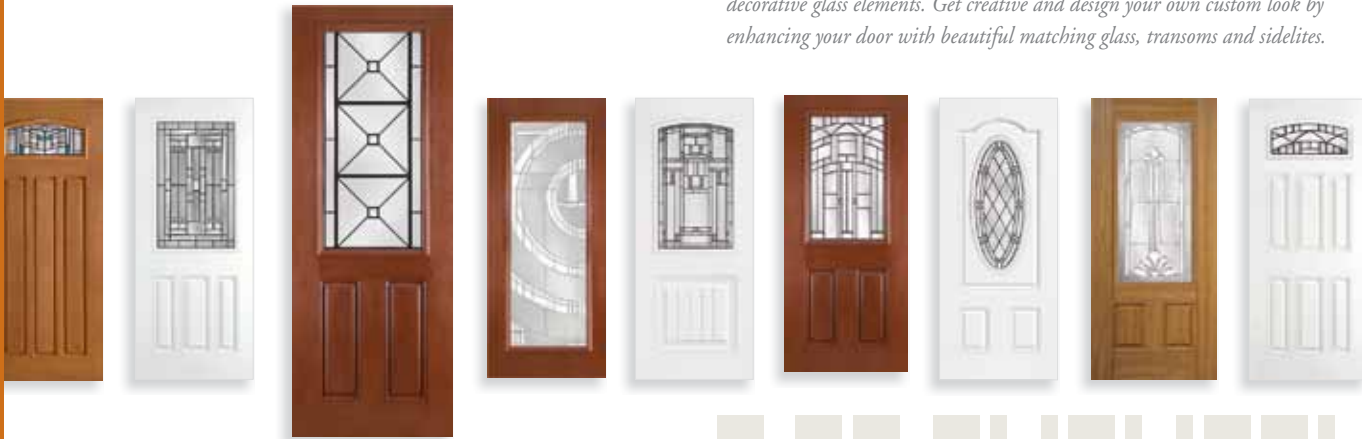

3 choose your door

- **BAR** Barrington® Oak Textured
- **BRM** Barrington® Mahogany Textured
- **BLT** Belleville® Oak Textured
- **BMT** Belleville® Mahogany Textured
- **BLS** Belleville® Smooth
- **OAK** Oakcraft®
- **SHD** Sta-Tru® HD Steel
- **MHD** Masonite® HD Steel



Sample doors shown. Complete offering of available doors and glass styles displayed throughout the catalog.

Selecting the right door can bring years of enjoyment and hassle-free maintenance that will leave a lasting impression. Masonite Textured Fiberglass doors display exceptional, deep wood-grain detail, adding richness and significance to your home's exterior. Our smooth fiberglass doors are perfectly engineered for durability and longevity, plus they're easy-to-paint for a custom look. Masonite Steel doors offer security and protection for your peace of mind.

2 choose your glass

Maximize the beauty and visual impact of your new door by coordinating Masonite glass elements from our collection of exquisite designs. Decorative glass embraces natural light and transforms any entryway into a vision of beauty without compromise. So, add charm and sophistication to your home's entry, inside and out, with one of our superbly crafted glass designs offered in a variety of configurations. The choice is yours.



Design your own entrance



www.masonite.com
Visit our website and be amazed how **easy** it is to create the entrance that will reflect your style.

explore the difference

Masonite entry doors

more door options with more door value

We bring you more styles, designs, textures and sizes to choose from for your home. Homeowners, remodelers, architects and builders rely on Masonite for superior craftsmanship, durability and value in both fiberglass and steel doors. Choose from our extensive line of fiberglass and steel doors to make all your entrances grand.

Masonite Fiberglass Textured doors offer the look of real wood that is easily stainable with low maintenance and extreme durability.

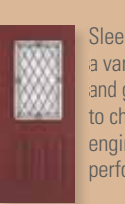
	BARRINGTON®			BELLEVILLE®		OAKCRAFT®	HD STEEL
	TRADITIONAL	CRAFTSMAN™	SIERRA® & FLAGSTAFF™	TEXTURED	SMOOTH	TEXTURED	STA-TRU® HD
	 Rich, classic elite line offers superior wood-grain authenticity with excellent durability and performance.	 Crafted in Mission style with your choice of our superior wood-grain texture engineered for excellent durability and performance.	 Southwest and country inspired designs in our superior wood-grain motif engineered for excellent durability and performance.	 Mix and match high-performing natural wood-grain textured door designs with your choice of decorative glass.	 Sleek look with a variety of door and glass options to choose from, engineered for performance.	 Our economical option of traditional designs with standard oak pattern in durable fiberglass.	 High-definition panel profile offering the security of 24-gauge steel for years of performance.
Wood Door Authenticity	★★★★★ Exceptional	★★★★★ Exceptional	★★★★★ Exceptional	★★★★ Excellent	★★★ Fine	★★★ Fine	★★ Good
Panel Profile	Raised moulding with elegant profile and recessed panels	Flat recessed panels with shaker style profile	Planked or non-planked panels with simple refined profiles	High-definition fiberglass profile	High-definition fiberglass profile	Standard profile	High-definition steel profile
Wood Grain Texture	Traditional oak & mahogany with variable-depth wood-grain	Rift cut oak & traditional mahogany with variable-depth wood-grain	Traditional & ribbon-striped mahogany with variable-depth wood-grain	Traditional oak & ribbon-striped mahogany with variable-depth wood-grain	Ultra-smooth	Traditional oak with single-depth wood-grain	Smooth
Edge (Stile) Construction	True square-edge	True square-edge	True square-edge	True square-edge	True square-edge	True square-edge	Interlocking
Edge (Stile) Material	Stainable/paintable premium hardwood	Stainable/paintable premium hardwood	Stainable/paintable premium hardwood	Stainable/paintable wood*	Paintable wood	Stainable/paintable wood	Paintable wood or steel
Finish Options	Stain or paint	Stain or paint	AvantGuard™ pre-finished, stain or paint	Stain or paint	Paint	Stain or paint	Pre-finished white or paint
Durability & Performance	Lifetime warranty [†]	Lifetime warranty [†]	Lifetime warranty [†]	Lifetime warranty [†]	Lifetime warranty [†]	25 year warranty [†]	5-20 years [†]
Composite Bottom Rail	✓	✓	✓	✓	✓	✓	✓
Rust Proof	✓	✓	✓	✓	✓	✓	✓
Dent Proof	✓	✓	✓	✓	✓	✓	✓
ENERGY STAR*	✓	✓	✓	✓	✓	✓	✓
Glass Options	Custom	Custom	Custom	Standard	Standard	Standard	Standard
Glass Designs	3	3	4 (sidelites only)	21+	21+	21+	21+
Glazing Assembly	Custom factory-glazed (installed)	Custom factory-glazed (installed)	Custom factory-glazed (installed)	Traditional glazing inserts	Traditional glazing inserts	Traditional glazing inserts	Traditional glazing inserts



Masonite Patio



Masonite has an extensive line of entry door products and accessories for your home including patio units, flush-glazed doors, steel frames, internal mini-blinds, stain kits and more.

*Qualifies in part as ENERGY STAR entryway in all four climate zones.
 ▲Belleville Mahogany has premium hardwood stiles.
 †All warranties are limited.

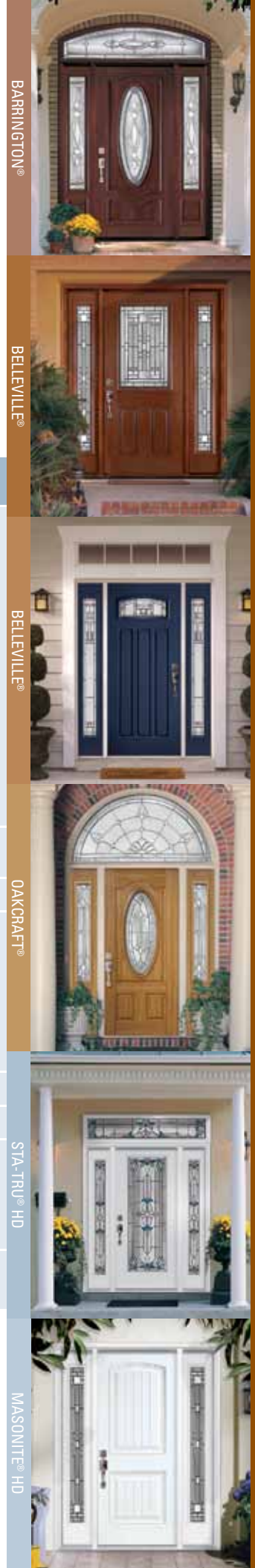

BARRINGTON®

BELLEVILLE®

BELLEVILLE®

OAKCRAFT®

STA-TRU® HD

MASONITE® HD

MASONITE. THE BEAUTIFUL DOOR.®

www.masonite.com

MASONITE. THE BEAUTIFUL DOOR.®

www.masonite.com

Barrington® essence of LUXURY & performance

Barrington® Traditional & Classic Door Styles

The most authentic replication of a wood door you can buy. These unique doors are carefully crafted with premium materials to create an authentic, custom wood door look.

THE BEAUTY OF A GENUINE HARDWOOD DOOR

- 1 Authentic Wood-Grain Texture**
 - ✓ composite door surface replicates an authentic mahogany or oak door appearance
 - ✓ features Masonite's variable depth, realistic, wood-grain texture
 - ✓ finishes easily and beautifully
- 2 Distinct Raised Moulding**
 - ✓ raised moulding creates beautiful shadow lines
 - ✓ panels are recessed below the surface at the stiles & rails
 - ✓ adds visual depth and character
- 3 Oversized Lock Block**
 - ✓ lock area is reinforced to accommodate premium door hardware
- 4 Stain-Grade Matching Hardwood Stiles**
 - ✓ built with True Square-Edge construction
 - ✓ engineered oak or mahogany capped stiles

ARCHITECTURALLY CORRECT DESIGN WITH CUSTOM GLAZING

- 5 Glass Frame Profiles**
 - ✓ designed to match the panel moulding for a consistent appearance
- 6 Raised Moulding Profile**
 - ✓ aligns vertically on door surface with glass frame
 - ✓ replicates authentic wood door construction
- 7 Factory-Glazed Doors & Sidelites**
 - ✓ yields wider glass and narrower stiles & rails without unsightly screw plugs



BARRINGTON® OAK TEXTURED with BR3 glass BAR-411-BR3-3

BARRINGTON® OAK TEXTURED with BR3 glass BAR-123-BR3-2

Barrington® BR1 brass caming

brass

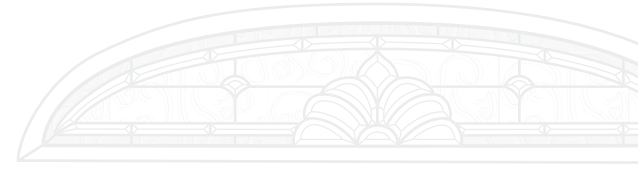

Masonite Fiberglass Doors are Engineered to Last a Lifetime

- proprietary, high-performance fiberglass doors are specially engineered to provide maximum protection and durability
- will not dent or rust, plus resists splitting, cracking and warping
- square-edge, engineered stiles provide excellent dimensional stability for harsh weather climates
- reinforced lock block provides strength and security for door hardware
- high-quality composite wood bottom rails are rot and corrosion resistance
- backed by a Lifetime Limited Warranty



- BARRINGTON® BR1 glass brass caming
- BARRINGTON® Oak Textured
- BRM Barrington® Mahogany Textured
- BRM Barrington® Mahogany Textured
- BARRINGTON® BR1 glass brass caming
- BARRINGTON® Oak Textured

BARRINGTON® BR1 glass brass caming



warmth and elegance...

exquisite wood-grain texture

antique black

Barrington® BR2 antique black caming



platinum

Barrington® BR3 platinum caming

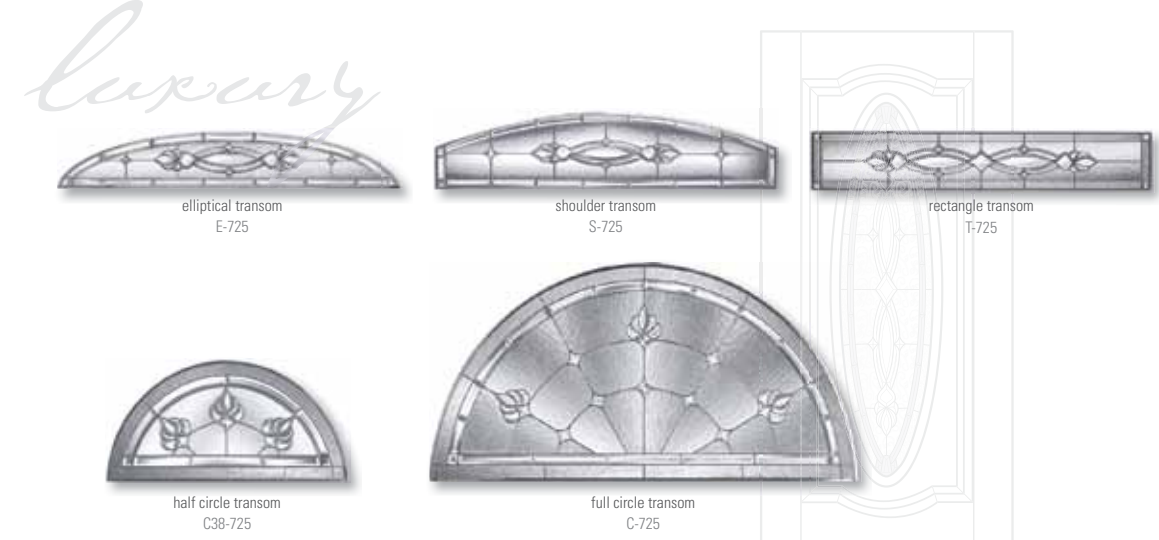
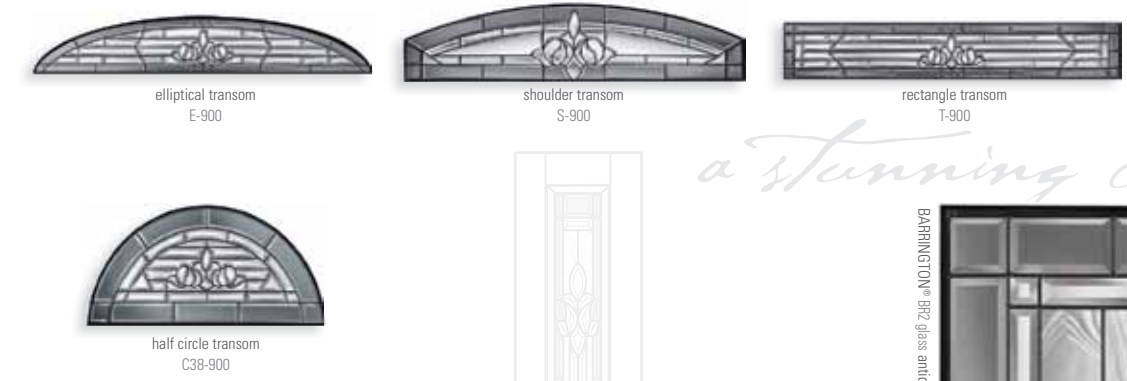

a stunning collection



Craftsman

architecturally inspired

3 Glass Designs

Barrington® Craftsman

Barrington® Craftsman Mission Styled Doors

Our Arts & Crafts/Mission style doors bring the beauty of hand-crafted premium rift-cut oak or old-growth mahogany with the durability and ease of our low maintenance premium fiberglass.

UNMATCHED CRAFTSMANSHIP FOR AN AUTHENTIC WOOD LOOK

1 Authentic Wood-Grain Texture

- ✓ composite door surface replicates an authentic mahogany or oak door appearance
- ✓ features Masonite's variable depth, wood-grain texture
- ✓ finishes easily and beautifully

2 Oversized Lock Block

- ✓ lock area is reinforced to accommodate premium door hardware

3 Stain-Grade Matching Hardwood Stiles

- ✓ assembled with True Square-Edge construction

4 Recessed Flat Panels

- ✓ Shaker sticking and recessed flat panels replicate a true Mission design
- ✓ adds visual depth and character

ARCHITECTURALLY CORRECT DESIGN WITH CUSTOM GLAZING

5 Profile Alignment

- ✓ recessed panels align perfectly with glass placement

6 Custom Glazing

- ✓ glass is integrated into door design — creating a simple, clean Mission style

7 Optional Dentil Shelves & SDL Lite Kits

- ✓ customize the door style with dentil shelving or simulated divided lite kits



BARRINGTON® CRAFTSMAN OAK TEXTURED with applied dentil shelf and SDL kit BRC-225-BS1-3

6'8" DOORS

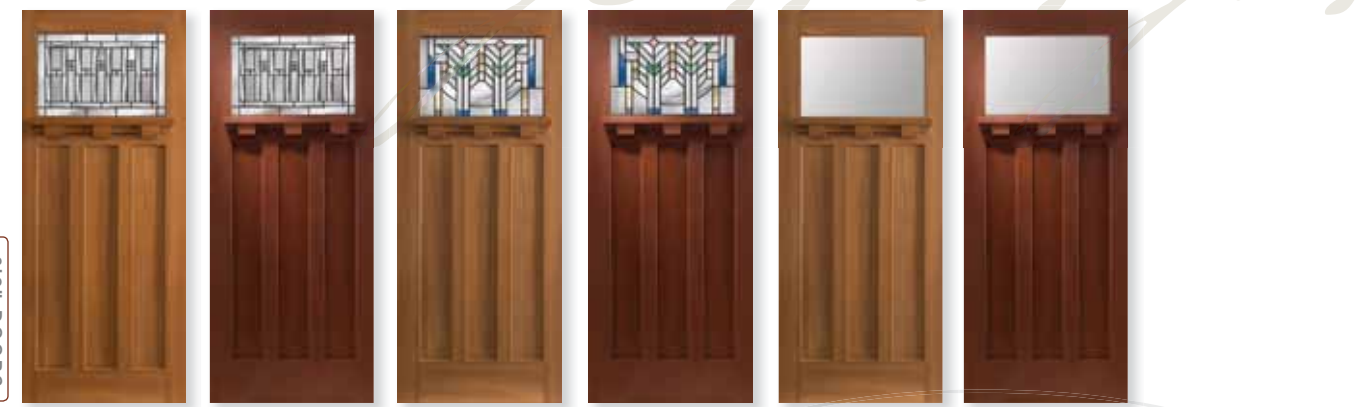

3 panel oak BC4 glass BRC-225-BC4-3 3 panel mahogany BC4 glass BCM-225-BC4-3 3 panel oak BC5 glass BRC-225-BC5-3 3 panel mahogany BC5 glass BCM-225-BC5-3 3 panel oak clear glass BRC-225-BS1-3 3 panel mahogany clear glass BCM-225-BS1-3

6'8" SIDELITES



1 panel oak BC4 glass BRCSL-609-BC4-1 1 panel mahogany BC4 glass BCM-609-BC4-1 1 panel oak BC5 glass BRCSL-609-BC5-1 1 panel mahogany BC5 glass BCM-609-BC5-1 1 panel oak clear glass BRCSL-609-BS1-1 1 panel mahogany clear glass BCM-609-BS1-1



BRC Barrington® Craftsman Oak
BCM Barrington® Craftsman Mahogany

simple & clean

BC4 antique black

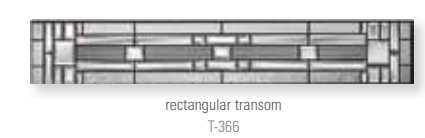

BC5 antique black

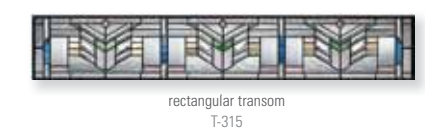
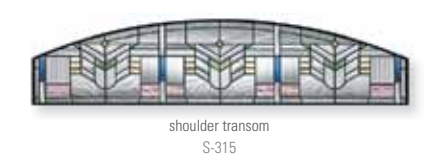

Masonite Fiberglass Doors are Engineered to Last a Lifetime

- proprietary, high-performance fiberglass doors are specially engineered to provide maximum protection and durability
- will not dent or rust, plus resists splitting, cracking and warping
- square-edge, engineered stiles provide excellent dimensional stability for harsh weather climates
- reinforced lock block provides strength and security for door hardware
- high-quality composite wood bottom rails are rot and corrosion resistance
- backed by a Lifetime Limited Warranty



Sierra™ & Flagstaff™

cottage&rustic



BARRINGTON® SIERRA™ 2 panel camber-top plank BSP-2

BARRINGTON® FLAGSTAFF™ plank BFS-P

Barrington® Sierra™ & Flagstaff™



6'8" DOORS

Sierra 2 panel camber-top plank BSP-2
Sierra 2 panel camber-top BSN-2
Sierra 2 panel camber-top plank arch-top BSP-2R
Sierra 2 panel camber-top arch-top BSN-2R
Sierra 1 panel camber-top plank BSP-1
Sierra 1 panel camber-top plank arch-top BSP-1R
Flagstaff plank BFS-P



8'0" DOORS

Sierra 2 panel camber-top plank BSP-2
Sierra 2 panel camber-top BSN-2
Sierra 2 panel camber-top plank arch-top BSP-2R
Sierra 2 panel camber-top arch-top BSN-2R
Sierra 1 panel camber-top plank BSP-1
Sierra 1 panel camber-top plank arch-top BSP-1R
Flagstaff plank BFS-P

Barrington® Sierra™ & Flagstaff™ Southwestern Inspired Designs

Barrington® Sierra™

Designed with a rustic flair, the Sierra Series incorporates gentle arches and beautiful old growth mahogany texture that finishes easily.

Barrington® Flagstaff™

Features our ribbon-stripped mahogany texture and soft planking lines to create a more contemporary look that finishes easily.

Masonite Fiberglass Doors are Engineered to Last a Lifetime

- proprietary, high-performance fiberglass doors are specially engineered to provide maximum protection and durability
- will not dent or rust, plus resists splitting, cracking and warping
- square-edge, engineered stiles provide excellent dimensional stability for harsh weather climates
- reinforced lock block provides strength and security for door hardware
- high-quality composite wood bottom rails are rot and corrosion resistance
- backed by a Lifetime Limited Warranty



1 Mahogany Texture

- ✓ beige-colored fiberglass facing with beautiful Masonite mahogany texture

2 Oversized Lock Block

- ✓ lock area is reinforced to accommodate premium door hardware

3 Stain-Grade Matching Mahogany Stiles

- ✓ finished with True Square-Edge construction

ARCHITECTURALLY CORRECT DESIGN WITH CUSTOM GLAZING

4 Factory-Glazed Sidelites

- ✓ matching full sidelites are factory-glazed, removing unsightly screw plugs



BARRINGTON® SIERRA™ 2 panel camber-top plank BSP-2



6'8" SIDELITES

8'0" SIDELITES

Sierra BR1 full sidelite BSNL-154-BR1-X
Sierra BR2 full sidelite BSNL-154-BR2-X
Sierra BR3 full sidelite BSNL-154-BR3-X
Sierra clear glass full sidelite BSNL-154-BS1-X
Sierra BR1 full sidelite BSNL-853-BR1-X
Sierra BR2 full sidelite BSNL-853-BR2-X
Sierra BR3 full sidelite BSNL-853-BR3-X
Sierra clear glass full sidelite BSNL-853-BS1-X



BSP Mahogany Textured
BSN Mahogany Textured
BFS Mahogany Textured

BSP Barrington® Sierra™ Plank
BSN Barrington® Sierra™ No Plank
BFS Barrington® Flagstaff™

Barrington® AvantGuard™

finish
a work of art



BARRINGTON® SIERRA™ with AvantGuard™ Spanish Cedar finish BAC-2R



BARRINGTON® SIERRA™ with AvantGuard™ Black Walnut finish BAW-2R

AvantGuard™ The Ideal Fusion of Wood & Fiberglass

1 Authentic Graining

- ✓ what makes AvantGuard superior is its appearance. Rather than simply applying stain over a textured fiberglass facing, an image layer is applied to a protective primer layer. This image is an authentic reproduction of the original master
- ✓ available in your choice of Spanish Cedar or Black Walnut finish

2 Ultimate Durability: Five Layers of Defense

- ✓ automotive clear coat: protects the door from UV rays and normal wear and tear
- ✓ image layer: UV stable image layer provides real wood aesthetic
- ✓ protective base coat: provides stability and adhesion between the image layer and the low-maintenance fiberglass facing
- ✓ textured fiberglass: Masonite's exclusive formula of fiberglass is more stable when subjected to temperature swings
- ✓ polyurethane foam: insulates your home and adheres the door components together

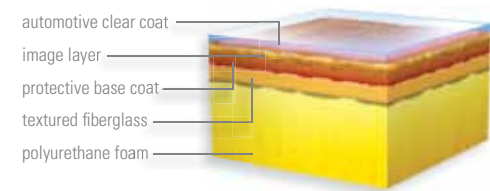

Note: Above diagram not to scale

3 Unprecedented 5 Year Finish Warranty*

- ✓ does not require top coating in the middle of the warranty period
- ✓ covers up to the full purchase price
- ✓ see Masonite.com for full warranty details. Barrington® Sierra™ and Barrington® Flagstaff™ door panels are covered by a lifetime limited warranty

	DOOR FINISH		
Criteria	Stained Wood	AvantGuard™	Stained Fiberglass
Appearance Authenticity	High	High	Medium
Top Coating Required	Yearly	After 5 Years	After 2-3 Years
Finish Warranty	1 Year	5 Year	2+ Years
Energy Star Rating **	Southern Zone Only	All Zones	All Zones
Weatherability	Low	High	Medium

*Stained finish refers to a conventional stain and topcoat system. Finish warranty may vary by product supplier.
**Refers to doors without glass

spanish cedar

AvantGuard™
PREFINISHED FIBERGLASS

- BAC Barrington® AvantGuard™ Spanish Cedar
- BAW Barrington® AvantGuard™ Black Walnut

6'-8" DOORS

6'-8" DOORS

6'-8" DOORS

8'-0" DOORS

8'-0" DOORS

8'-0" DOORS

spanish cedar

black walnut

spanish cedar

black walnut

Flagstaff™ plank BAC-P

Sierra™ 2 panel camber-top plank BAC-2

Sierra™ 2 panel camber-top plank arch-top BAC-2R

full lite BACSL-154-BR2

full lite BACSL-154-BS1

Flagstaff™ plank BAW-P

Sierra™ 2 panel camber-top plank BAW-2

Sierra™ 2 panel camber-top plank arch-top BAW-2R

full lite BAWSL-154-BR2

full lite BAWSL-154-BS1

Flagstaff™ plank BAC-P

Sierra™ 2 panel camber-top plank BAC-2

Sierra™ 2 panel camber-top plank arch-top BAC-2R

full lite BACSL-853-BR2

full lite BACSL-853-BS1

Flagstaff™ plank BAW-P

Sierra™ 2 panel camber-top plank BAW-2

Sierra™ 2 panel camber-top plank arch-top BAW-2R

full lite BAWSL-853-BR2

full lite BAWSL-853-BS1



BARRINGTON® SIERRA™ with AvantGuard™ Spanish Cedar finish door BAC-2 – sidelites BACSL-154-BR2

AvantGuard finish available on all sizes of Barrington Sierra and Flagstaff doors shown. See pages 90-91 for more details.

black walnut



BARRINGTON® FLAGSTAFF™ with AvantGuard™ Black Walnut finish BAW-P

Belleville® Textured

shaping grand entryways

BELLEVILLE®
Fiberglass Entry Doors

elegance & Durability



BELLEVILLE® HOLLISTER® MAHOGANY TEXTURED with Astor™ glass - door BMT-404-388-1 - sidelites BMTSL-450-388-1

BELLEVILLE® MAHOGANY TEXTURED with Rockland™ glass BMT-108-586-2



Belleville® Textured – Super Wood Door Beauty

A great combination of real wood door appearance with the long-lasting performance of our superior fiberglass.

authentic

- 1 **Real Wood Appearance**
 - ✓ premium variable-depth oak or ribbon-stripped mahogany grain textures create the look of natural wood
 - ✓ finishes easily and beautifully
- 2 **High-Definition Profile Panels**
 - ✓ adds architectural interest and elegance
- 3 **Large Reinforced Lock Block**
 - ✓ provides added strength and security for door hardware
- 4 **True Square-Edge Construction**
 - ✓ creates the most authentic wood door appearance
- 5 **Stain-Grade Matching Mahogany Stiles**
 - ✓ a premium feature on our Belleville Mahogany line



6.8" DOORS

6.8" DOORS

8.0" DOORS

flush oak BLT-X 1 panel arch oak BLT-1 2 panel square-top oak BLT-2 3 panel arch-top oak BLT-3 4 panel blank-top oak BLT-4BT 4 panel New England oak BLT-4NE 6 panel blank-top oak BLT-6BT 6 panel oak BLT-6 6 panel mahogany BMT-6 6 panel camber-top oak BLT-6CT 8 panel parliament oak BLT-8 Hollister™ 2 panel mahogany BMT-2 2 panel universal oak BLTSL-2 2 panel universal mahogany BMTSL-2 flush mahogany BMTSL-X 8 panel parliament oak BLT-8 Hollister™ 2 panel mahogany BMT-2 2 panel universal oak BLTSL-2 flush mahogany BMTSL-X

Masonite Fiberglass Doors are Engineered to Last a Lifetime

- proprietary, high-performance fiberglass doors are specially engineered to provide maximum protection and durability
- will not dent or rust, plus resists splitting, cracking and warping
- square-edge, engineered stiles provide excellent dimensional stability for harsh weather climates
- reinforced lock block provides strength and security for door hardware
- high-quality composite wood bottom rails are rot and corrosion resistance
- backed by a Lifetime Limited Warranty



Sample doors shown.
For complete offering
of doors and glass styles,
see pages 92-94.

mahogany

Belleville® Smooth *great looks* design & flexibility

BELLEVILLE®
Fiberglass Entry Doors



BELLEVILLE® SMOOTH with Panama™ glass doors BLS-304-725-3 – sidelites BLS-450-725-1 – transom E-725

BELLEVILLE® SMOOTH with Zavalla™ glass BLS-404-537-2

Belleville® Smooth – High-Performance Fiberglass

Designed with high-definition profiles that capture the beauty and elegance of a wood door with the low-maintenance of fiberglass.

1 High-Performance Smooth Surface

- ✓ ideal for painting and will not rust or dent

2 High-Definition Panel Profile

- ✓ adds architectural interest and elegance

3 Reinforced Lock Block

- ✓ provides added strength and security for door hardware

4 True Square-Edge Construction

- ✓ provides an authentic wood door appearance

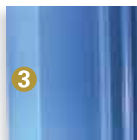

Masonite Fiberglass Doors are Engineered to Last a Lifetime

- proprietary, high-performance fiberglass doors are specially engineered to provide maximum protection and durability
- will not dent or rust, plus resists splitting, cracking and warping
- square-edge, engineered stiles provide excellent dimensional stability for harsh weather climates
- reinforced lock block provides strength and security for door hardware
- high-quality composite wood bottom rails are rot and corrosion resistance
- backed by a Lifetime Limited Warranty



6'8" DOORS

6'8" DOORS

8'0" DOORS

- flush BLS-X
- 2 panel square-top BLS-2
- 3 panel arch-top BLS-3
- 4 panel blank-top BLS-4BT
- 4 panel New England BLS-4NE
- 6 panel blank-top BLS-6BT
- 6 panel BLS-6
- 6 panel camber-top BLS-6CT
- 8 panel parliament BLS-8
- 2 panel universal BLS-2
- flush BLS-X
- flush BLS-X
- 2 panel square-top BLS-2
- 6 panel BLS-6
- 8 panel parliament BLS-8
- 2 panel universal BLS-2

- Sample doors shown.
- For complete offering of doors and glass styles, see pages 92-94.

smooth hardwood door beauty

Oakcraft®

the look of natural wood

OAKCRAFT® with Element™ glass – door OAK-404-329-2 – sidelites OAK-450-328-1



Oakcraft® Doors – Adding Richness

Experience the beauty of genuine oak without the maintenance.

Our Oakcraft line of doors feature a standard oak texture and panel profile that provide a low maintenance, economical option that is backed with a 25 year limited warranty.

AS WITH ALL MASONITE FIBERGLASS DOORS, OAKCRAFT DOORS INCLUDE THESE STANDARD FEATURES:

- 1 High-Performance Fiberglass**
 - ✓ proprietary door facings are specially engineered to provide maximum protection and durability
 - ✓ adds architectural appeal and elegance
- 2 Square-Edge Construction**
 - ✓ provides an authentic wood door appearance
- 3 Reinforced Lock Block**
 - ✓ provides strength and security for door hardware
- 4 Rot-Resistant Bottom Rails**
 - ✓ high-quality composite wood bottom rails are rot and corrosion resistant



wood-grain texture

Oakcraft®
Wood-grain Textured
FIBERGLASS ENTRY DOORS

incredible warmth

6'8" DOORS

- flush OAK-X
- 3 panel arch-top OAK-3
- 4 panel blank-top OAK-4BT
- 4 panel New England OAK-4NE
- 4 panel eyebrow OAK-4
- 6 panel OAK-6

6'8" DOORS

- 9 panel OAK-9
- flush OAK-X
- 1 panel OAK-1
- 1 panel with 3/4 lite cutout OAK-1

8'0" DOORS

- flush OAK-X
- 6 panel OAK-6
- flush OAK-X
- 1 panel OAK-1



OAKCRAFT® with Quattro™ glass OAK-122-957-X

• Sample doors shown.
• For complete offering of doors and glass styles, see pages 92-94.

easy finishing

Steel



MASONITE® HD STEEL with Naples™ glass – door MHD 2-panel camber-top plank – sidelites MHDSL-152-366-X

entry doors

The Ultimate Steel Door Collection

Masonite Steel doors feature high-definition decorative panel profiles that closely replicate the appearance of a high-end wood door with the ultimate in security. They truly make a statement with the addition of Specialty™ Glass inserts for a grand entrance.

Standard features for steel-edge & wood-edge

- High-Definition Panel Profile**
 - ✓ creates excellent shadow lines and distinct panel designs
- Internal Blocking**
 - ✓ lock area is reinforced with a lock block to provide solid mounting surface
- Two Finish Options**
 - ✓ Masonite® HD features a baked-on primer for a more durable finish
 - ✓ Sta-Tru® HD has a prefinished white surface (no initial finishing required on door panel)
- Rot-Resistant Bottom Rail**
 - ✓ high-performance composite material is utilized on all bottom rails

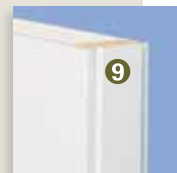
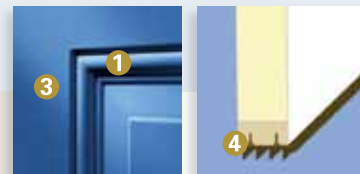

Steel-Edge features

- Interlocking Steel-Edge**
 - ✓ has six 90° steel bends in each edge to ensure stability and resist warping
- Square-Edge Design**
 - ✓ wood door appearance
- Vinyl Extrusion**
 - ✓ locks facings together and provides an insulated thermal barrier
- Steel Reinforcements**
 - ✓ hinges are flush mounted into steel reinforcements to help prevent hinge sag

✓ 90-minute fire label available (opaque doors only)

Wood-Edge features

- Engineered Construction**
 - ✓ finger-jointed hinge stile
 - ✓ LVL lock stile
- Interlocking Design**
 - ✓ grooved stiles add strength and structural rigidity
 - ✓ steel facings wrap over stiles with a "J" bend

✓ 20-minute fire label available (opaque doors only)



STA-TRU® HD LIMITED 20-YEAR WARRANTY
MASONITE® HD LIMITED 5-YEAR WARRANTY
MASONITE® UTILITY LIMITED 1-YEAR WARRANTY

Sta-Tru® HD
PREFINISHED STEEL ENTRY DOORS

Masonite® HD
HIGH-DEFINITION STEEL ENTRY DOORS

Masonite®
UTILITY STEEL DOORS

Sta-Tru and Masonite High-Definition Steel Designs



Decorative

- SHD Sta-Tru® High-Definition Prefinished Steel
- MHD Masonite® High-Definition Steel
- MUS Masonite® Utility Steel

Distinctive

Masonite Utility Steel Designs

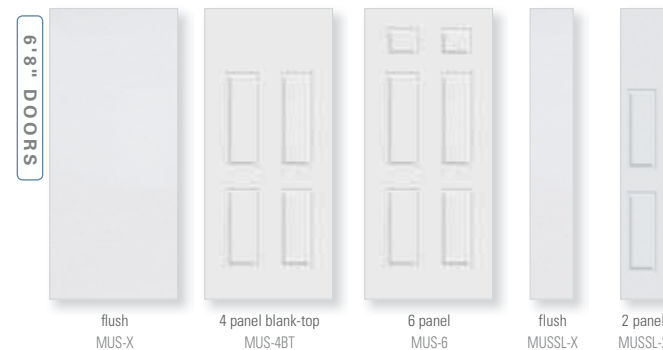

• Sample doors shown.
• For complete offering of doors and glass styles, see pages 88-89.

MASONITE® HD STEEL 1 panel arch

MASONITE® HD STEEL 4 panel



MASONITE® HD STEEL 9 panel

your style glass

transforming
light into
brilliance

Decorative glass embraces natural light and transforms any entryway into a vision of beauty without compromise. So, add charm and sophistication to your home's entry, inside and out, with one of our superbly crafted glass designs offered in a variety of configurations. The choice is yours.



Sienna® glass 106-817

BELLEVILLE® HOLLISTER™ MAHOGANY TEXTURED with Element™ glass BMT-404-328-1



MasoniteCodesDefined

BLT - 106 - 817 - 1

door acronym glass shape & size glass design & coming # visible door panels

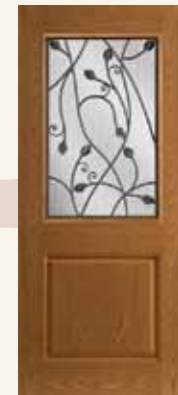

BLT-106-817-1
2236

- BLT Belleville® Oak Textured
- BMT Belleville® Mahogany Textured
- BLS Belleville® Smooth
- OAK Oakcraft®
- SHD Sta-Tru® HD Steel
- MHD Masonite® HD Steel



SL = sidelite

BLTSL-450-817-1

2236 = glass dimensions 22" x 36"

DoorAcronym

GlassLiteSize&Shape

Rectangle Lite	S-Top Lite	Camber-Top Lite	Round-Top Lite	Oval Lite	Fan Lite	Camber-Top Fan Lite
105 22" x 36" Round-Top	137 22" x 10" Camber-Top Fan	300 20" x 57" Oval				
106 22" x 36" Rectangle	149 8" x 64" Round-Top	304 16" x 40" Oval				
107 22" x 37" Camber-Top	151 8" x 64" Rectangle	306 14" x 54" Oval				
109 22" x 64" Round-Top	152 7" x 64" Rectangle	404 22" x 48" Rectangle				
120 20" x 64" Rectangle	200 8" x 36" Round-Top	410 22" x 47" S-Top				
122 22" x 64" Rectangle	201 8" x 58" Round-Top	450 8" x 48" Rectangle				
129 8" x 36" Rectangle	203 8" x 42" Round-Top	810 22" x 80" Rectangle				
135 22" x 10" Fan	228 22" x 10" Rectangle	852 8" x 80" Rectangle				
136 7.5" x 18.5" Rectangle						

Sample selection of door panels shown

#VisibleDoorPanels

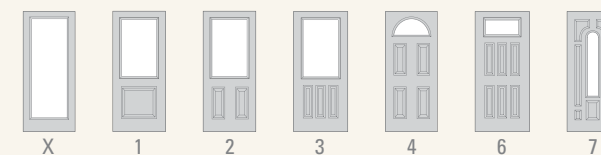

GlassDesign&Caming

Specialty decorative glass index

Alston™ 338.....	38
Aurora™ 207.....	50
Chandler™ 551•553.....	70
Element™ 328.....	32
Fundy™ 264.....	66
Georgian™ 515•517•518.....	58
Glace™ 430•433.....	68
Madrid™ 900.....	54
Marquise™ 777•778•779.....	46
Monaco™ 315.....	44
Naples™ 366.....	48
Navarro™ 793.....	36
Oxford™ 137.....	72
Panama™ 724•725.....	56
Quattro™ 957.....	52
Riviera™ 615•620.....	64
Rockland™ 566.....	42
Sienna™ 817.....	34
Victorian™ 856.....	62
Woodbridge™ 442•727•920 443•728•921.....	60
Zavalla™ 537.....	40

clearglass

External Grille Inserts.....	74
Internal Blinds.....	74
Internal Grille Inserts.....	75
One Lite Inserts.....	75
Venting Inserts.....	74

Design your own entrance



www.masonite.com
Visit our website and be amazed how easy it is to create the entrance that will reflect your style.

All Specialty sealed units are made with tempered safety glass and comply with the following:
ANSI Z97.1-1984
16 CFR 1201 II
CAN/CGSB-12.1M90

element
..... GLASS



OAKCRAFT® with Element™ glass -- door OAK-404-328-2 -- sidelite OAKSL-450-328-1



- granite beveled glass
- granite glass
- clear beveled glass
- antique black caming



antique black
328caming

- **BLT** Belleville® Oak Textured
- **BMT** Belleville® Mahogany Textured
- **BLS** Belleville® Smooth
- **OAK** Oakcraft®
- **SHD** Sta-Tru® HD Steel
- **MHD** Masonite® HD Steel

Element™ 328antique black



106-328-1 106-328-1P 106-328-2 106-328-3 107-328-1 107-328-1P 107-328-2 107-328-3 137-328-3 137-328-4 137-328-6 404-328-1 404-328-2 129-328-1 450-328-1 404-328-1 404-328-2 450-328-1

All color images of doors represent 6'8" configurations. See line art chart for 8'0" door configurations. For specific door availability, please refer to charts on pages 96-98.

BLT BLS
BLS-106-328-3
2236

BLT BLS SHD MHD
BLT-106-328-1
2236

MHD
MHD-106-328-1P
2236

BLT BMT BLS OAK SHD MHD
BMT-106-328-2
2236

MHD
MHD-107-328-1P
2237 camber-top

SHD MHD
SHD-107-328-1
2237 camber-top

BLT BLS OAK SHD MHD
BLT-107-328-2
2237 camber-top

BLT BLS
BLS-107-328-3
2237 camber-top

BLT BLS OAK SHD MHD
BLT-137-328-4
2210 camber-top

BLT BLS
BLT-137-328-3
2210 camber-top

BLT BLS
BLT-137-328-6
2210 camber-top

BLT BLS OAK SHD MHD
BLS-404-328-2
2248

BLT BMT BLS OAK SHD MHD
BMTSL-450-328-1
848

BLT BMT BLS OAK SHD MHD
BMT-404-328-1
2248

sophisticated style



oceana glass

wrought iron

sienna
.....GLASS

Least Obscure **PRIVACY RATING** Most Obscure

1 2 3 4 5 6 7 **8** 9

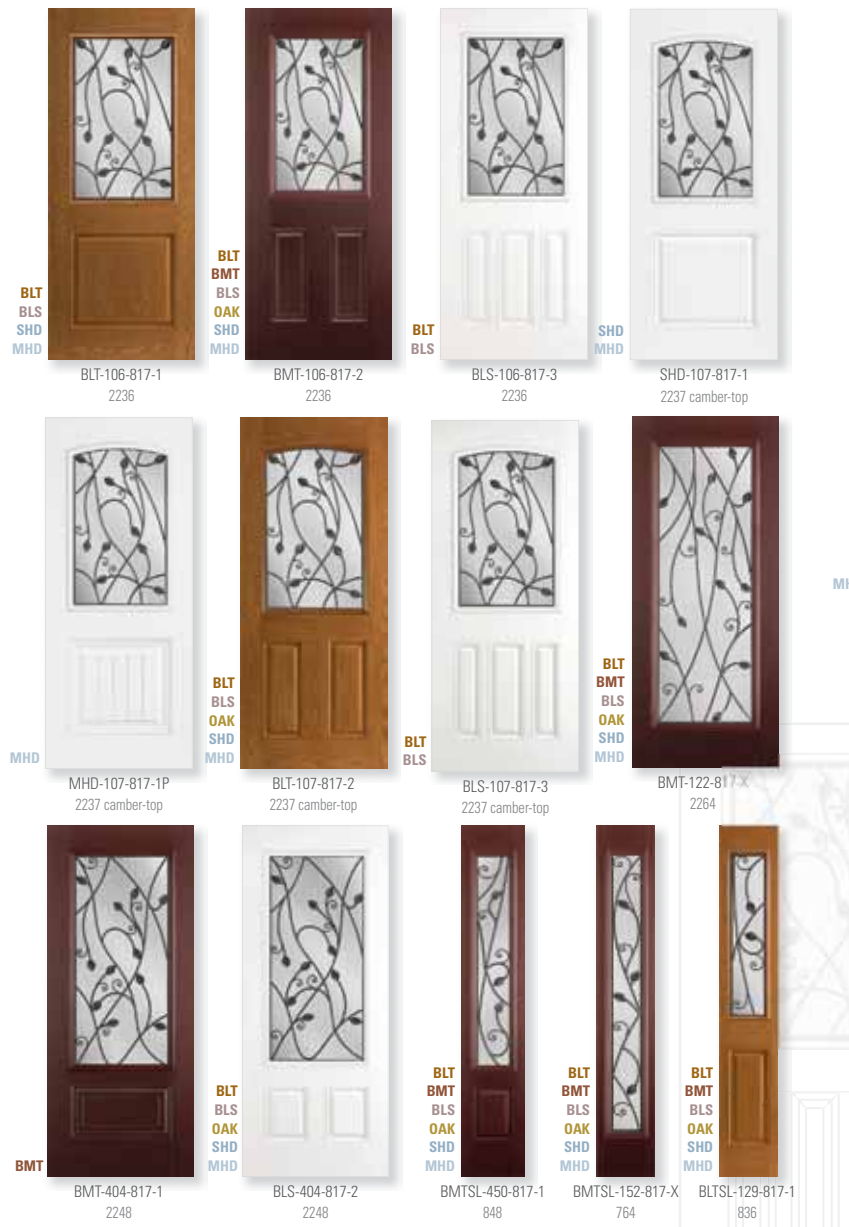

BLT
BLS
SHD
MHD

BLT-106-817-1
2236

BLT
BMT
BLS
OAK
SHD
MHD

BMT-106-817-2
2236

BLT
BLS

BLS-106-817-3
2236

SHD
MHD

SHD-107-817-1
2237 camber-top

MHD

MHD-107-817-1P
2237 camber-top

BLT
BLS
OAK
SHD
MHD

BLT-107-817-2
2237 camber-top

BLT
BLS

BLS-107-817-3
2237 camber-top

BLT
BMT
BLS
OAK
SHD
MHD

BMT-122-817-X
2264

MHD

MHD-106-817-1P
2236

BMT

BMT-404-817-1
2248

BLT
BLS
OAK
SHD
MHD

BLS-404-817-2
2248

BLT
BMT
BLS
OAK
SHD
MHD

BMTSL-450-817-1
848

BLT
BMT
BLS
OAK
SHD
MHD

BMTSL-152-817-X
764

BLT
BMT
BLS
OAK
SHD
MHD

BLTSL-129-817-1
836

HD STEEL with Sienna™ glass – door MHD-404-817-2

Sienna™ 817 wrought iron

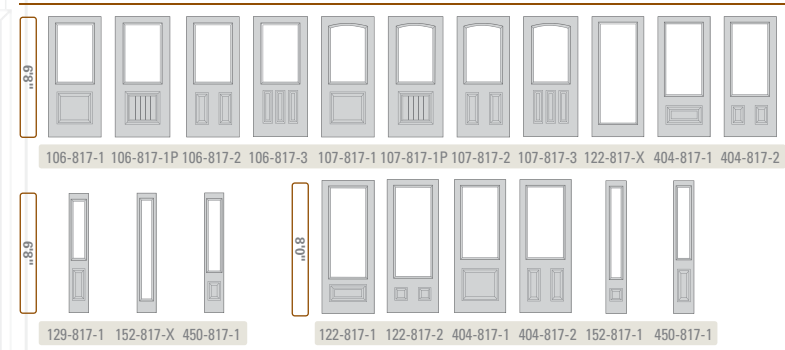

106-817-1 106-817-1P 106-817-2 106-817-3 107-817-1 107-817-1P 107-817-2 107-817-3 122-817-X 404-817-1 404-817-2

129-817-1 152-817-X 450-817-1 122-817-1 122-817-2 404-817-1 404-817-2 152-817-1 450-817-1

All color images of doors represent 6'8" configurations. See line art chart for 8'0" door configurations. For specific door availability, please refer to charts on pages 96-98.



wrought iron 817

- BLT Belleville® Oak Textured
- BMT Belleville® Mahogany Textured
- BLS Belleville® Smooth
- OAK Oakcraft®
- SHD Sta-Tru® HD Steel
- MHD Masonite® HD Steel

inspired by nature

BELLEVILLE® OAK TEXTURED with Sienna™ glass BLT-107-817-3

BELLEVILLE® MAHOGANY TEXTURED with Sienna™ glass BMTSL-450-817-1



BELLEVILLE® SMOOTH with Navarro™ glass – door BLS-137-793-3 – sidelite BLSSL-152-793-X – transom T-793

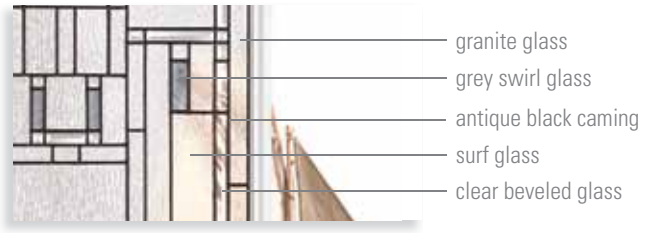

Least Obscure **PRIVACY RATING** Most Obscure

1	2	3	4	5	6	7	8	9
---	---	---	---	---	---	---	----------	---

antique black
793caming

- **BLT** Belleville® Oak Textured
- **BMT** Belleville® Mahogany Textured
- **BLS** Belleville® Smooth
- **OAK** Oakcraft®
- **SHD** Sta-Tru® HD Steel
- **MHD** Masonite® HD Steel

Navarro™ 793antique black



All color images of doors represent 6'8" configurations. See line art chart for 8'0" door configurations. For specific door availability, please refer to charts on pages 96-98.

navarro
GLASS

BLT BLS SHD MHD BLS-106-793-1 2236

MHD BLS MHD-106-793-1P 2236

BLT BMT BLS OAK SHD MHD BMT-106-793-2 2236

BLT BLS BLS-106-793-3 2236

SHD MHD SHD-107-793-1 2237 camber-top

MHD MHD-107-793-1P 2237 camber-top

BLT BLS OAK SHD MHD BLS-107-793-2 2237 camber-top

BLT BLS BLS-107-793-3 2237 camber-top

BLT BLS BLS-137-793-3 2210 camber-top

BLT BLS OAK SHD MHD BLS-137-793-4 2210 camber-top

BLT BLS BLS-137-793-6 2210 camber-top

BLT BLS BLS-228-793-3 2210

BLT BLS OAK BLS-228-793-4 2210

BLT BLS BLS-228-793-6 2210

BMT BMT-404-793-1 2248

BLT BLS OAK SHD MHD BLS-404-793-2 2248

BLT BMT BLS OAK SHD MHD BMTSL-450-793-1 848

BLT BMT BLS OAK SHD MHD BLSSL-152-793-X 764

BLT BMT BLS OAK SHD MHD BLTSL-129-793-1 836

BELLEVILLE® SMOOTH with Navarro™ glass BLS-228-793-6

BELLEVILLE® OAK Textured with Navarro™ glass BLT-137-793-3

unsurpassed quality ships

alston GLASS

- BLT Belleville® Oak Textured
- BMT Belleville® Mahogany Textured
- BLS Belleville® Smooth
- OAK Oakcraft®
- SHD Sta-Tru® HD Steel
- MHD Masonite® HD Steel



BELLEVILLE® HOLLISTER™ MAHOGANY TEXTURED with Alston™ glass — door BMT-404-338-1 — sidelite BMTSL-450-338-1



Alston™ 338 antique black

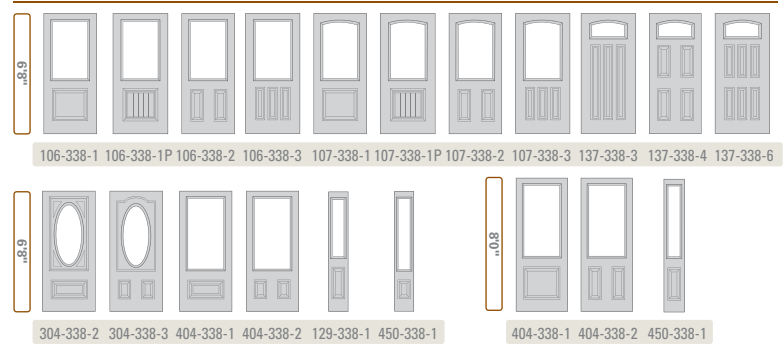

All color images of doors represent 6'8" configurations. See line art chart for 8'0" door configurations. For specific door availability, please refer to charts on pages 96-98.

The Alston family features tempered surf glass. This unique art glass further enhances the privacy and elegance of this series.

appealing choices

BELLEVILLE® MAHOGANY TEXTURED with Alston™ glass BMT-106-338-2

BLT BLS BLT-137-338-3 2210 camber-top

BELLEVILLE® SMOOTH with Alston™ glass BLS-106-338-3

zavalla GLASS



DOOR COMBINATIONS	Option1	Option2	Option3	Option4	Option5	Option6	Option7	Option8
D	()						
SD	(())	()				
DS	(())	())	()	
S DS	(())	(())	(())	(())
DD	(())	(())	(())	(())

D - doorlite S - sidelite

Zavalla glass options are limited only by your imagination. No lefts or rights, no ups and downs, no rules – each Zavalla insert is designed to be rotated – the orientation and arrangement of each insert in your door system is entirely reflective of your own personal wishes.



BELLEVILLE® SMOOTH with Zavalla™ glass — door BLS-404-537-2 — sidelite BLSSL-450-537-1

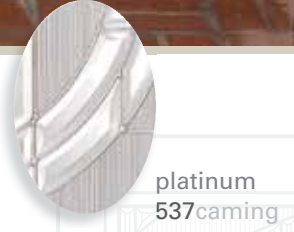

- BLT Belleville® Oak Textured
- BMT Belleville® Mahogany Textured
- BLS Belleville® Smooth
- OAK Oakcraft®
- SHD Sta-Tru® HD Steel
- MHD Masonite® HD Steel



Zavalla™ 537platinum

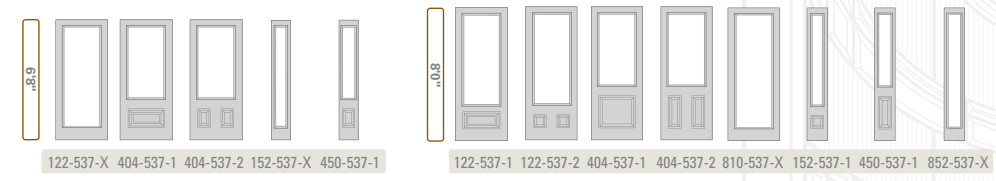

All color images of doors represent 6'8" configurations. See line art chart for 8'0" door configurations. For specific door availability, please refer to charts on pages 96-98.

unique options

rockland

GLASS

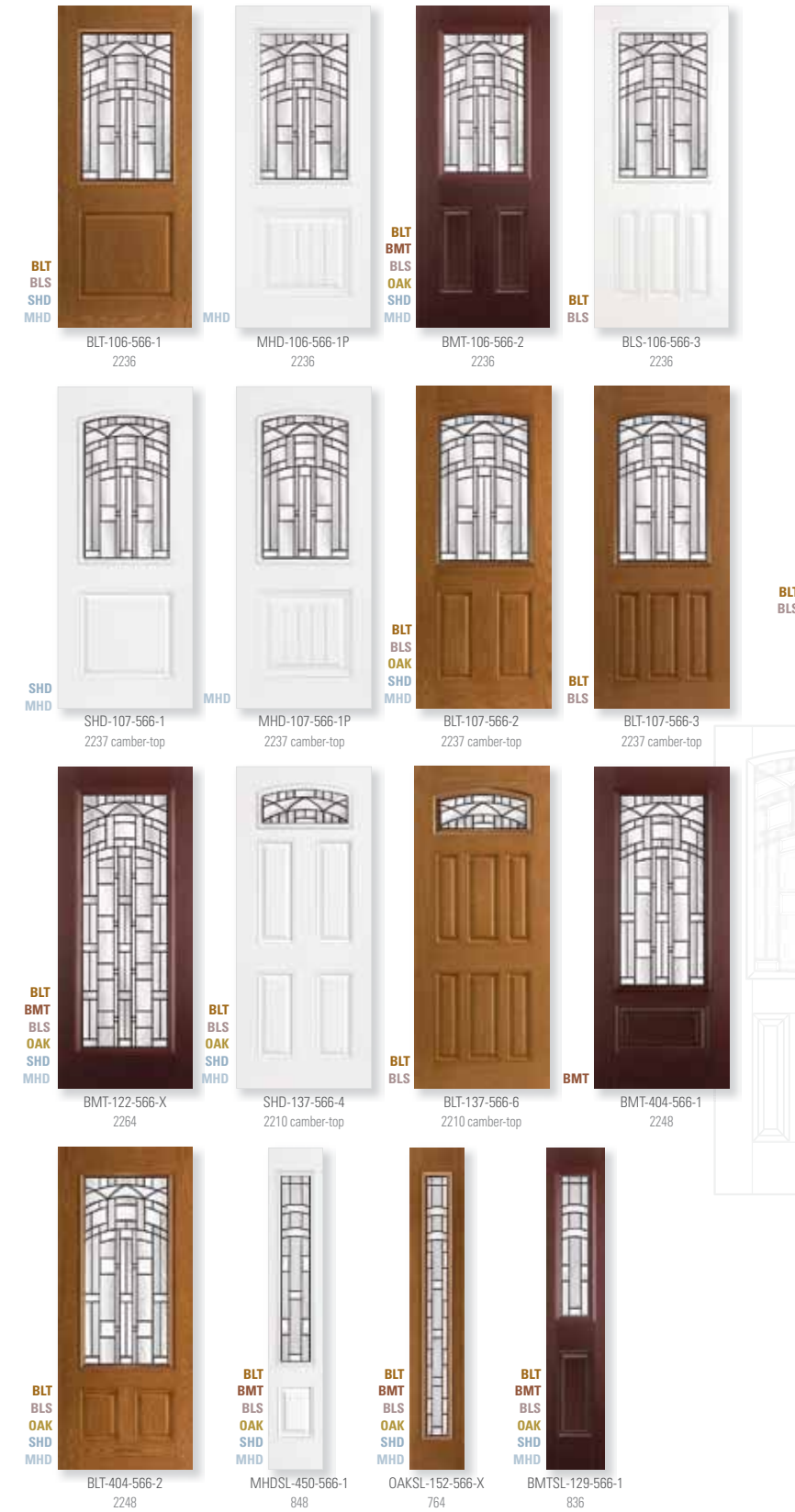

HD STEEL with Rockland® glass
MHD-107-566-1P



OAKCRAFT® with Rockland® glass OAK-404-566-2

grand impressions



BELLEVILLE® MAHOGANY TEXTURED with Rockland® glass — door BMT-404-566-2



- antique black caming
- clear beveled glass
- granite glass
- clear swirl glass

antique black
566caming

- BLT Belleville® Oak Textured
- BMT Belleville® Mahogany Textured
- BLS Belleville® Smooth
- OAK Oakcraft®
- SHD Sta-Tru® HD Steel
- MHD Masonite® HD Steel



Rockland 566antique black

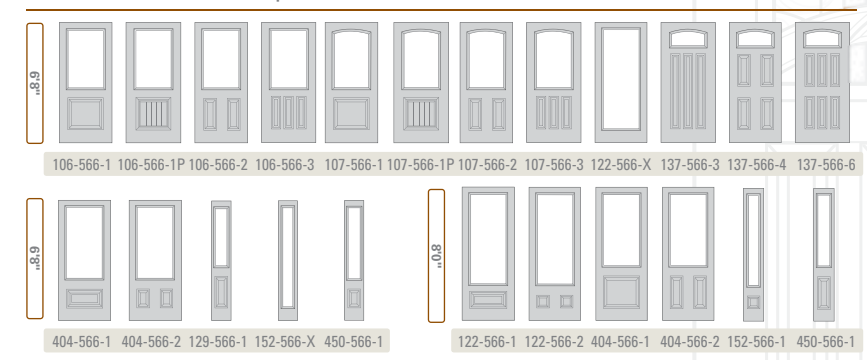

All color images of doors represent 6'8" configurations. See line art chart for 8'0" door configurations. For specific door availability, please refer to charts on pages 96-98.

Monaco GLASS

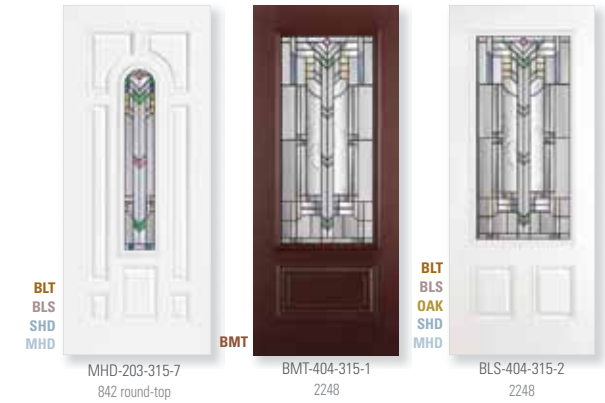
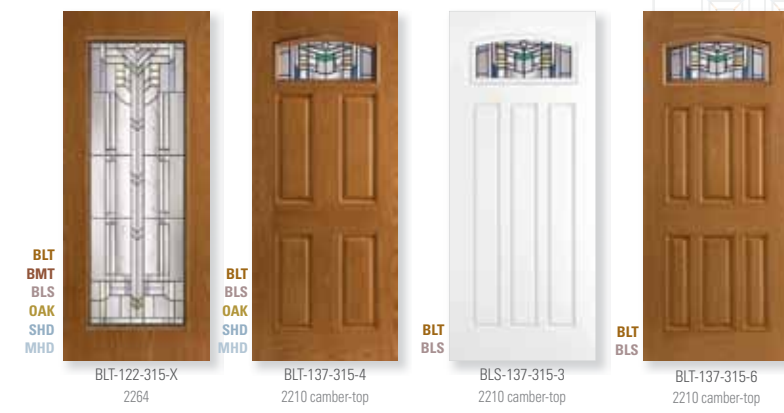
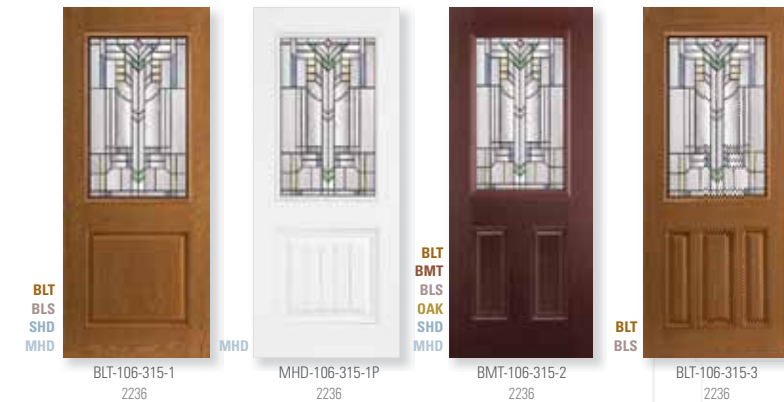

splash of color



STA-TRU® HD STEEL with Monaco® glass – door SHD-122-315-X – sidelite SHDSL-152-315-X – transom T-315

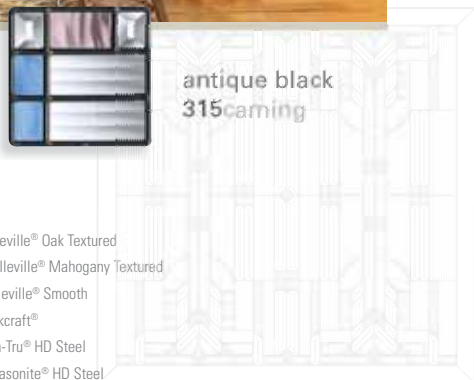

Least Obscure PRIVACY RATING Most Obscure

1	2	3	4	5	6	7	8	9
---	---	---	---	---	---	---	---	---

- BLT Belleville® Oak Textured
- BMT Belleville® Mahogany Textured
- BLS Belleville® Smooth
- OAK Oakcraft®
- SHD Sta-Tru® HD Steel
- MHD Masonite® HD Steel

Monaco™ 315 antique black

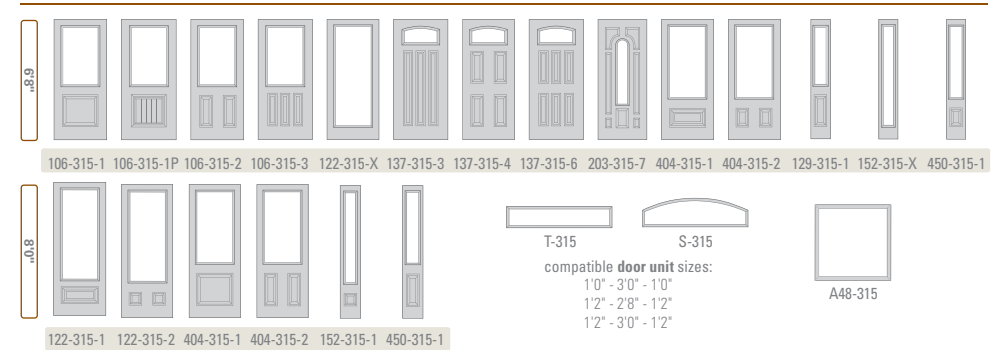

All color images of doors represent 6'8" configurations. See line art chart for 8'0" door configurations. For specific door availability, please refer to charts on pages 96-98.

marquise GLASS



BELLEVILLE® SMOOTH with Marquise™ glass — door BLS-106-779-1 — sidelite BLSSL-152-779-X

brass
777caming

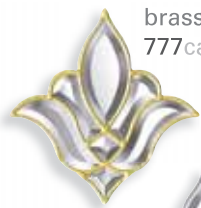

platinum
778caming



antique black
779caming



- **BLT** Belleville® Oak Textured
- **BMT** Belleville® Mahogany Textured
- **BLS** Belleville® Smooth
- **OAK** Oakcraft®
- **SHD** Sta-Tru® HD Steel
- **MHD** Masonite® HD Steel



Marquise™ 777brass 778platinum 779antique black

645brass 646platinum 647antique black

105-777-2	105-777-3	106-777-1	106-777-1P	106-777-2	106-777-3	109-777-X	120-777-X	122-777-X	135-777-4	135-777-6	203-777-7	300-777-X	304-777-2	304-777-3	306-777-1	404-777-1	404-777-2
105-778-2	105-778-3	106-778-1	106-778-1P	106-778-2	106-778-3	109-778-X	120-778-X	122-778-X	135-778-4	135-778-6	203-778-7	300-778-X	304-778-2	304-778-3	306-778-1	404-778-1	404-778-2
106-779-1 106-779-1P 106-779-2 106-779-3 120-779-X 122-779-X 300-779-X 304-779-2 304-779-3 404-779-1 404-779-2																	
410-777-2	129-777-1	149-777-X	151-777-X	152-777-X	200-777-1	450-777-1	122-777-1	122-777-2	201-777-7	306-777-2	404-777-1	404-777-2	152-777-1	450-777-1			
410-778-2	129-778-1	149-778-X	151-778-X	152-778-X	200-778-1	450-778-1	122-778-1	122-778-2	201-778-7	306-778-2	404-778-1	404-778-2	810-778-X	152-778-1	450-778-1	852-778-X	
129-779-1 152-779-X 450-779-1 122-779-1 122-779-2 404-779-1 404-779-2 152-777-1 450-779-1																	

All color images of doors represent 6'8" configurations. See line art chart for 8'0" door configurations. For specific door availability, please refer to charts on pages 96-98.

BLT BLS OAK SHD MHD BLT-105-777-2 2236 round-top

BLT BLS OAK SHD MHD BLT-105-778-3 2236 round-top

BLT BLS OAK SHD MHD MHD-106-778-1 2236

BLT BMT BLS OAK SHD MHD BMT-106-778-2 2236

BLT BLS OAK SHD MHD BLS-106-777-3 2236

C-646

BLT BLS OAK SHD MHD SHD-109-778-X 2264 round-top

BLT BLS OAK SHD MHD SHD-120-779-X 2064

BLT BMT BLS OAK SHD MHD BMT-122-777-X 2264

BLT BLS OAK SHD MHD SHD-135-777-4 2210 sun

BLT BLS OAK SHD MHD BLT-135-778-6 2210 sun

BLT BLS OAK SHD MHD BLT-201-778-7 858 round-top

MHD MHD-106-778-1P 2236

BLT BLS OAK SHD MHD BLT-203-777-7 842 round-top

BLT BLS OAK SHD MHD SHD-300-777-X 2057 oval

BLT BLS OAK SHD MHD BLT-304-779-3 1640 oval

BMT BMT-404-779-1 2248

BLT BLS OAK SHD MHD BLS-404-777-2 2248

BLT BLS OAK SHD MHD BLT-306-778-1 1555 oval

BLT BLS OAK SHD MHD OAK-410-778-2 2247 s-top

BLT BMT BLS OAK SHD MHD BMTSL-450-779-1 848

BLT BLS OAK SHD MHD BLTSL-200-778-1 836 round-top

BLT BMT BLS OAK SHD MHD BLSSL-152-779-X 764

BLT BLS OAK SHD MHD MHDLSL-149-778-X 864 round-top

BLT BMT BLS OAK SHD MHD BMTSL-129-777-1 836

BMT BMT-304-777-2 1640 oval

transforms light into brilliance

naples GLASS

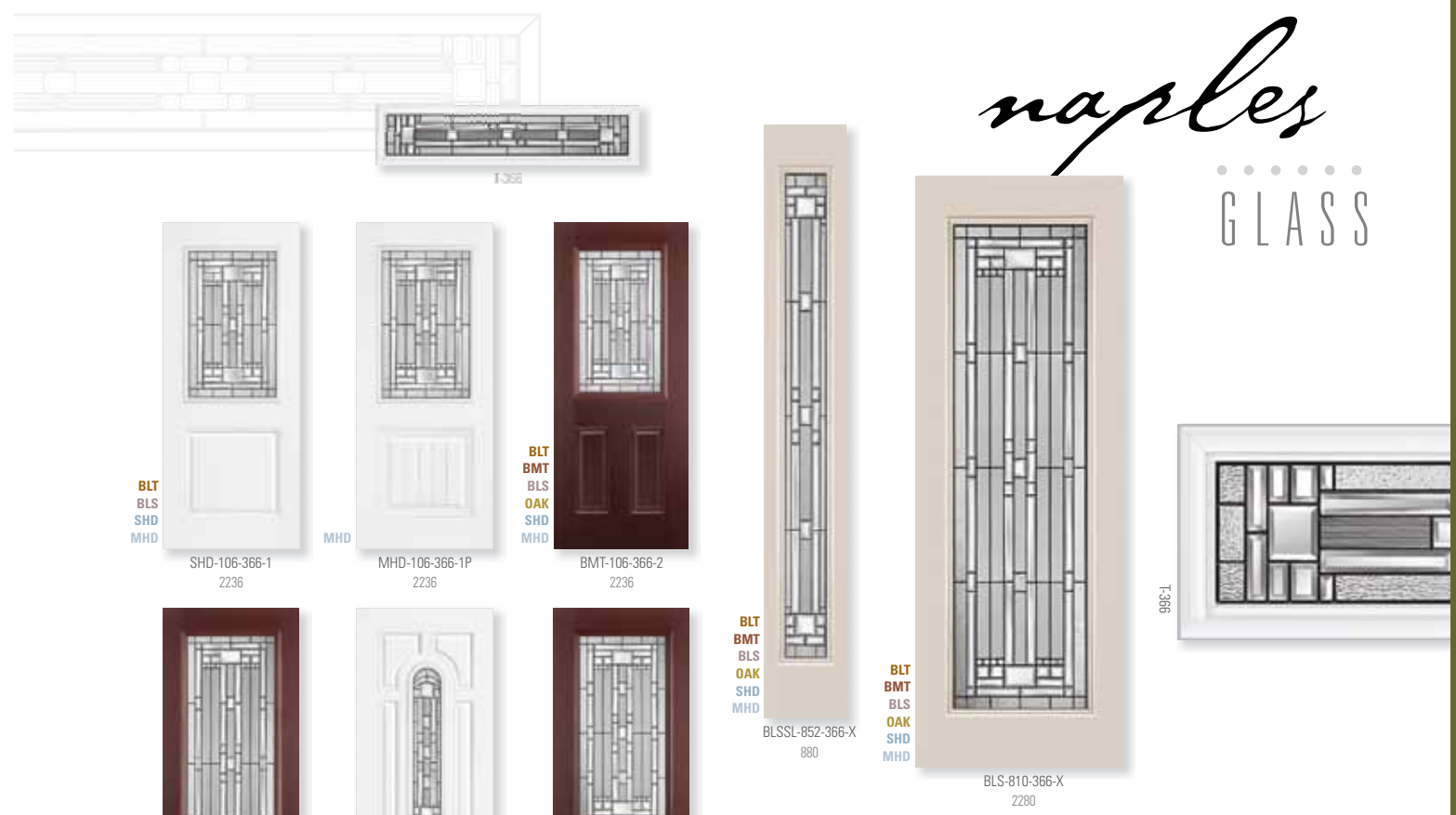

HD STEEL with Naples™ glass – door MHD-106-366-2 – sidelite MHDSL-129-366-1 – transom T-366

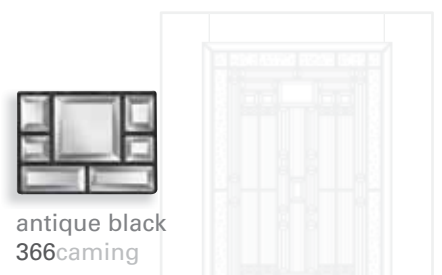
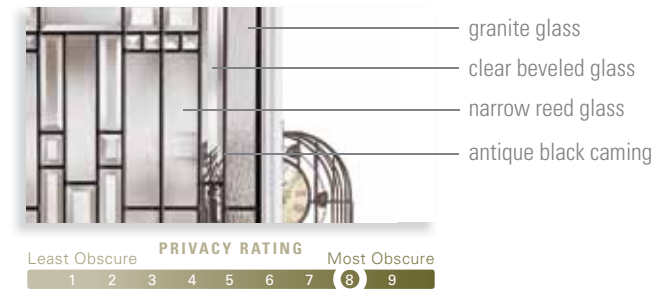

Naples™ 366antique black



All color images of doors represent 6'8" configurations. See line art chart for 8'0" door configurations. For specific door availability, please refer to charts on pages 96-98.

- BLT Belleville® Oak Textured
- BMT Belleville® Mahogany Textured
- BLS Belleville® Smooth
- OAK Oakcraft®
- SHD Sta-Tru® HD Steel
- MHD Masonite® HD Steel

captivating



BLT-106-366-3
2236

quattro
GLASS



BELLEVILLE® HOLLISTER™ MAHOGANY TEXTURED with Quattro™ glass – door BMT-404-957-1 – sidelite BMTSL-450-957-1 – transom T-957



ocean glass
wrought iron



wrought iron957

Least Obscure **PRIVACY RATING** Most Obscure
1 2 3 4 5 6 7 **8** 9

Dynamic expressions

compatible door unit sizes:
1'0" - 3'0" - 1'0"
1'2" - 2'8" - 1'2"
1'2" - 3'0" - 1'2"

Quattro™ 957wrought iron

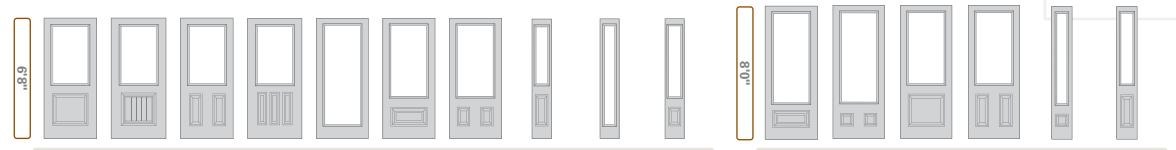

106-957-1 106-957-1P 106-957-2 106-957-3 122-957-X 404-957-1 404-957-2 129-957-1 152-957-X 450-957-1 122-957-1 122-957-2 404-957-1 404-957-2 152-957-1 450-957-1

All color images of doors represent 6'8" configurations. See line art chart for 8'0" door configurations. For specific door availability, please refer to charts on pages 96-98.

- BLT Belleville® Oak Textured
- BMT Belleville® Mahogany Textured
- BLS Belleville® Smooth
- OAK Oakcraft®
- SHD Sta-Tite® HD Steel
- MHD Masonite® HD Steel

BELLEVILLE® SMOOTH with Quattro™ glass BLS-106-957-3

BELLEVILLE® MAHOGANY TEXTURED with Quattro™ glass BMT-122-957-X

madrid GLASS



- **BLT** Belleville® Oak Textured
- **BMT** Belleville® Mahogany Textured
- **BLS** Belleville® Smooth
- **OAK** Oakcraft®
- **SHD** Sta-Tru® HD Steel
- **MHD** Masonite® HD Steel

 BLT BLS OAK SHD MHD BLT-105-900-2 2236 round-top	 BLT BLS BLS-105-900-3 2236 round-top	 BLT BLS SHD MHD BLT-106-900-1 2236	 MHD MHD-106-900-1P 2236	 BLT BMT BLS OAK SHD MHD BMT-106-900-2 2236	 SHD MHD SHD-107-900-1 2237 camber-top	 MHD MHD-107-900-1P 2237 camber-top
 BLT BLS OAK SHD MHD BLT-107-900-2 2237 camber-top	 BLT BLS BLS-107-900-3 2237 camber-top	 BLT BMT BLS OAK SHD MHD BMT-122-900-X 2264	 SHD MHD SHD-135-900-4 2210 sun	 BLT BLS BLT-135-900-6 2210 sun	 BLT BLS BLT-137-900-3 2210 camber-top	 SHD MHD SHD-137-900-4 2210 camber-top
 BLT BLS SHD MHD BLT-137-900-6 2210 camber-top	 BLT BLS SHD MHD BLT-203-900-7 842 round-top	 BLT BLS BLS-228-900-3 2210	 BLT BLS OAK BLT-228-900-4 2210	 BLT BLS BLS-228-900-6 2210	 BLT BLS OAK SHD MHD OAK-300-900-X 2057 oval	 BLT BLS OAK SHD MHD MHD-304-900-3 1640 oval
 BLT SHD MHD SHD-306-900-1 1555 oval	 BMT BMT-404-900-1 2248	 BLT BLS OAK SHD MHD BLT-404-900-2 2248	 BLT BLS OAK SHD MHD SHD-410-900-2 2247 s-top	 BLT BMT BLS OAK SHD MHD BLTSL-450-900-1 848	 BLT BLS OAK SHD MHD SHDSL-200-900-1 836 round-top	 BLT BMT BLS OAK SHD MHD BMTSL-152-900-X 764
 BLT BMT BLS OAK SHD MHD BLSSL-129-900-1 836						



grey beveled glass
clear beveled glass
antique black caming

Least Obscure	PRIVACY RATING									Most Obscure
	1	2	3	4	5	6	7	8	9	
	1	2	3	4	5	6	7	8	9	

antique black
900caming

Madrid 900antique black

6'8"																
6'8"																
6'8"																

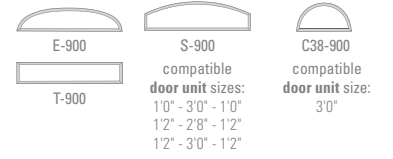

All color images of doors represent 6'8" configurations. See line art chart for 8'0" door configurations. For specific door availability, please refer to charts on pages 96-98.

Timeless Design



BELLEVILLE® OAK TEXTURED with Panama™ glass - door BLT-122-725-X - sidelite BLTSL-152-725-X - transom E-725

panama
GLASS



Least Obscure PRIVACY RATING Most Obscure
1 2 3 4 5 6 7 8 9

- BLT Belleville® Oak Textured
- BMT Belleville® Mahogany Textured
- BLS Belleville® Smooth
- OAK Oakcraft®
- SHD Sta-Tru® HD Steel
- MHD Masonite® HD Steel

brass
724caming
platinum
725caming

Panama™ 724brass 725platinum

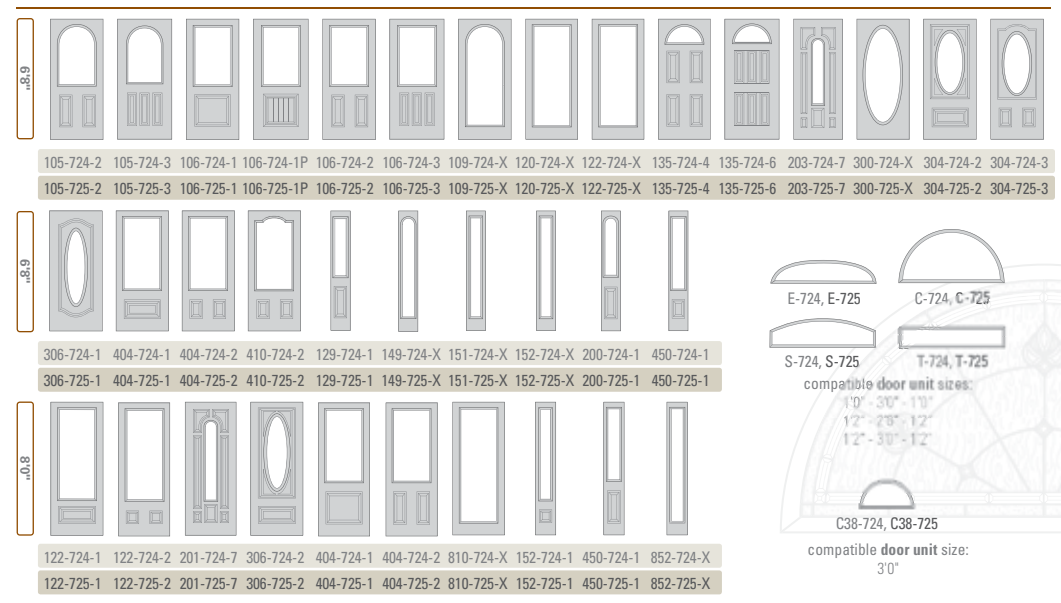

inviting entrances

georgian
GLASS



 BLT BLS OAK SHD MHD BLS-105-515-2 2236 round-top	 BLT BLS BLS-105-517-3 2236 round-top	 BLT BLS SHD MHD BLS-106-517-1 2236	 MHD MHD-106-518-1P 2236	 BLT BMT BLS OAK SHD MHD BLT-106-511-2 2236	 BLT SHD MHD BLT-306-517-1 1555 oval	 BMT BMT-404-517-1 2248	 BLS BLS-106-518-3 2236		
 SHD MHD SHD-107-515-1 2237 camber-top	 MHD MHD-107-517-1P 2237 camber-top	 BLT BLS OAK SHD MHD BLT-107-517-2 2237 camber-top	 BLT BLS BLT-107-517-3 2237 camber-top	 BLS BLS-122-517-X 2264	 SHD MHD SHD-136-517-8 718	 BLT BLS OAK SHD MHD BLT-300-515-X 2057 oval	 BLS BLS-304-517-3 1640 oval	 BLT SHD MHD BLT-306-517-1 1555 oval	 BMT BMT-404-517-1 2248
 BLS BLS-404-515-2 2248	 BMT BMTSL-450-517-1 848	 BLT BLS OAK SHD MHD BLTSL-200-517-1 836 round-top	 BLS BMT BLS OAK SHD MHD BLSL-152-517-X 764	 MHD MHD-129-518-1 836					

- BLT Belleville® Oak Textured
- BMT Belleville® Mahogany Textured
- BLS Belleville® Smooth
- OAK Oakcraft®
- SHD Sta-Tru® HD Steel
- MHD Masonite® HD Steel

BELLEVILLE® OAK TEXTURED with Georgian™ glass -- door BLT-107-517-3



Georgian™ 515brass 517platinum 518antique black 645brass 646platinum 647antique black



All color images of doors represent 6'8" configurations. See line art chart for 8'0" door configurations. For specific door availability, please refer to charts on pages 96-98.

exceptional quality

Woodbridge GLASS



brass
caming
442
727
920



platinum
caming
443
728
921



HD STEEL with Woodbridge™ glass – door MHD-106-920-1P



PRIVACY RATING										
Least Obscure	1	2	3	4	5	6	7	8	9	Most Obscure

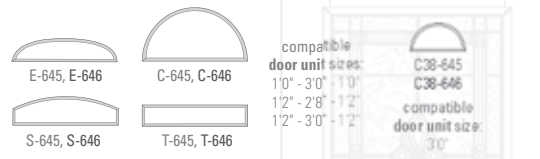

Woodbridge™ 442 • 727 • 920 brass 443 • 728 • 921 platinum 645 brass 646 platinum

6'8"	6'8"	8'0"
105-920-2	105-920-3	106-920-1
106-920-2	106-920-3	120-442-X
122-442-X	137-920-3	137-920-4
137-920-6	228-920-3	228-920-4
228-920-6	300-442-X	304-442-2
304-442-3	306-442-1	106-921-1
106-921-2	106-921-3	120-443-X
122-443-X	228-921-3	228-921-4
228-921-6	300-443-X	304-443-2
304-443-3	306-443-1	122-442-1
122-442-2	306-442-2	404-442-1
404-442-2	152-727-1	152-920-1
450-920-1	122-443-1	122-443-2
306-443-2	404-443-1	404-443-2
152-728-1	152-921-1	450-728-1
404-443-1	404-443-2	129-727-1
152-727-X	152-920-X	200-920-1
450-920-1	122-443-1	122-443-2
306-443-2	404-443-1	404-443-2
152-728-1	152-921-1	450-728-1

All color images of doors represent 6'8" configurations. See line art chart for 8'0" door configurations. For specific door availability, please refer to charts on pages 96-98.

simply beautiful



victorian GLASS

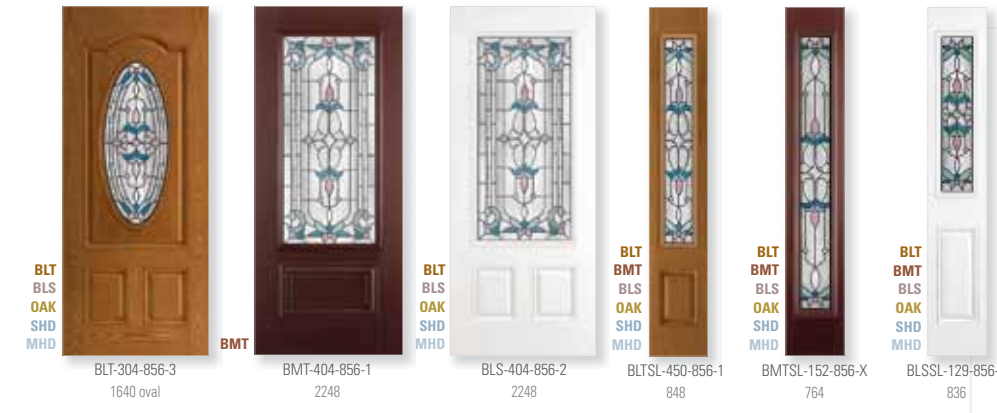
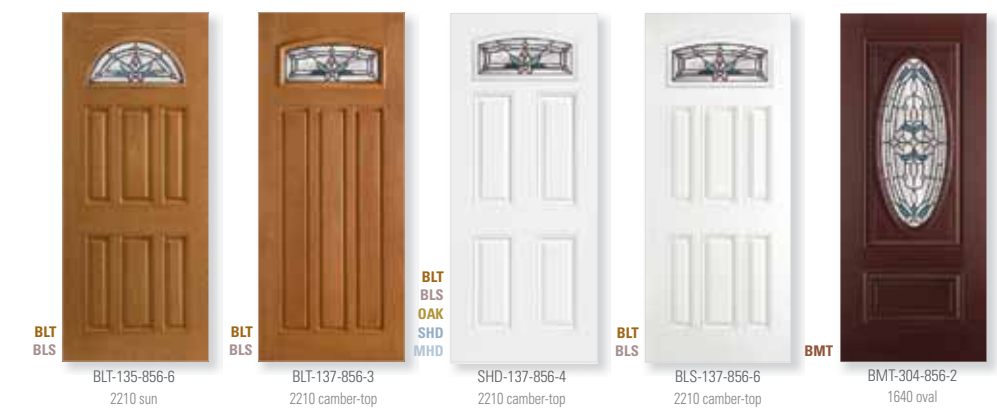
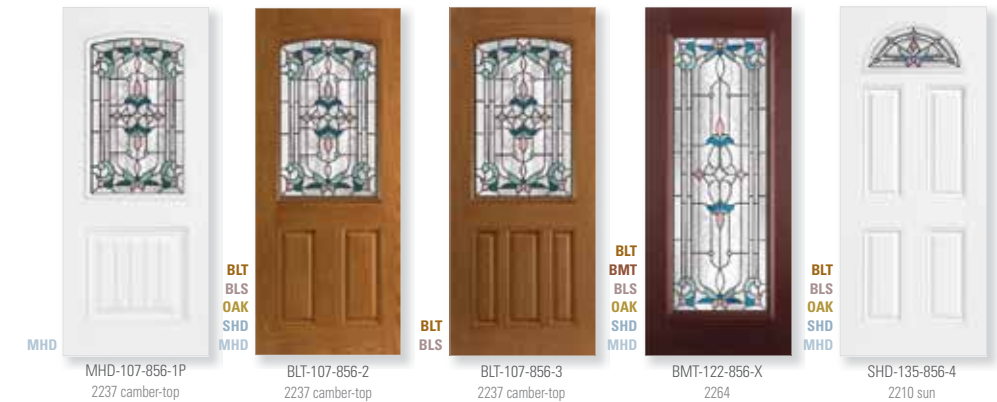
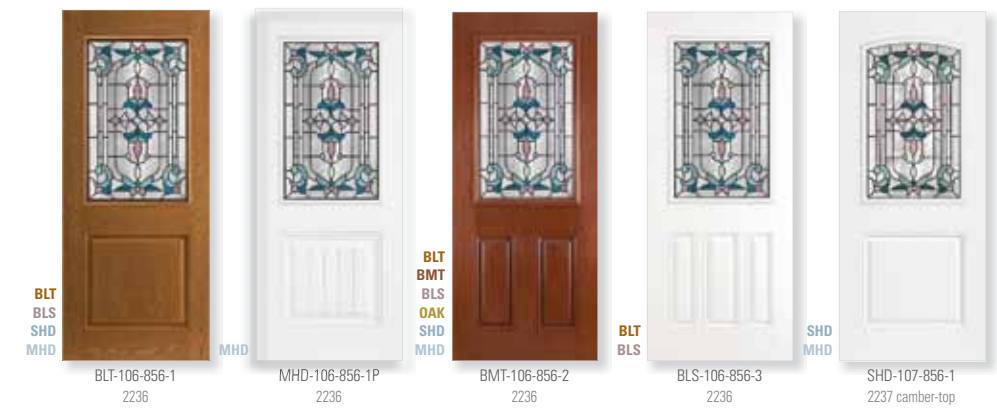

BELLEVILLE™ SMOOTH with Victorian™ glass BLS-106-856-1

BELLEVILLE™ HOLLISTER™ MAHOGANY TEXTURED with Victorian™ glass – door BMT-404-856-1 – sidelite BMTSL-152-856-X – transom T-856

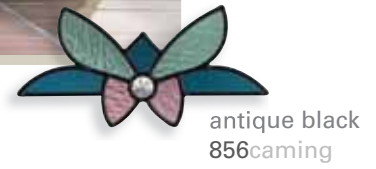

- BLT Belleville® Oak Textured
- BMT Belleville® Mahogany Textured
- BLS Belleville® Smooth
- OAK Oakcraft®
- SHD Sta-Tru® HD Steel
- MHD Masonite® HD Steel

PRIVACY RATING										
Least Obscure	1	2	3	4	5	6	7	8	9	Most Obscure
								8		

Victorian™ 856antique black

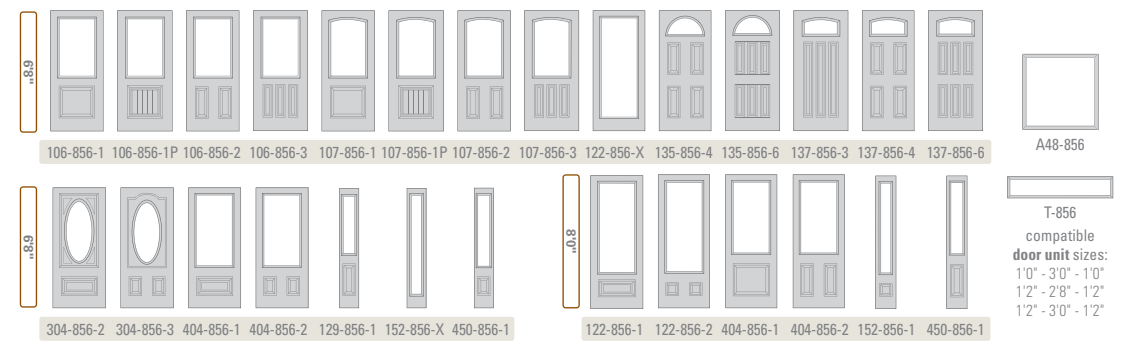

All color images of doors represent 6'8" configurations. See line art chart for 8'0" door configurations. For specific door availability, please refer to charts on pages 96-98.

enchanting



riviera GLASS



BELLEVILLE® OAK TEXTURED with Riviera™ glass – door BLT-105-620-3 – sidelite BLT-200-620-1



brass
615caming
615 has clear bevels

brass
620caming
620 has glue chip bevels

- BLT Belleville® Oak Textured
- BMT Belleville® Mahogany Textured
- BLS Belleville® Smooth
- OAK Oakcraft®
- SHD Sta-Tru® HD Steel
- MHD Masonite® HD Steel



Riviera™ 615 • 620brass



All color images of doors represent 6'8" configurations. See line art chart for 8'0" door configurations. For specific door availability, please refer to charts on pages 96-98.

impressive detail



BELLEVILLE® SMOOTH with Riviera™ glass BLS-122-615-X

fundy GLASS



BELLEVILLE® OAK TEXTURED with Fundy™ glass — door BLT-106-264-3



etched glass
clear glass



etched 264



Fundy™ 264etched



All color images of doors represent 6'8" configurations. See line art chart for 8'0" door configurations. For specific door availability, please refer to charts on pages 96-98.

- BLT BLS SHD MHD BLT-106-264-1 2236
- MHD MHD-106-264-1P 2236
- BLT BLS SHD MHD BLT-106-264-2 2236
- BLS BLS BLS-106-264-3 2236
- BMT BMT-404-264-1 2248
- BLT BLS OAK SHD MHD BLT-120-264-X 2064
- BLS OAK SHD MHD SHD-135-264-4 2210 sun
- BLT BMT BLS OAK SHD MHD BMT-122-264-X 2264
- BLS OAK SHD MHD BLT-300-264-X 2057 oval
- BMT BMT-304-264-2 1640 oval
- BLT BLS OAK SHD MHD BLT-404-264-2 2248
- BLT BMT BLS OAK SHD MHD BLSSL-450-264-1 848
- BLT BMT BLS OAK SHD MHD BLTSL-152-264-X 764
- BLT BMT BLS OAK SHD MHD BMTSL-129-264-1 836



BMT-404-264-1 2248

BLT BLS BLT-135-264-6 2210 sun

- BLT Belleville® Oak Textured
- BMT Belleville® Mahogany Textured
- BLS Belleville® Smooth
- OAK Oakcraft®
- SHD Sta-Tru® HD Steel
- MHD Masonite® HD Steel

quality characteristics



BELLEVILLE® SMOOTH with Glace™ glass - door BLS-106-433-2

glace GLASS

brass caming option
clear beveled glass

Least Obscure PRIVACY RATING Most Obscure
1 2 3 4 5 6 7 8 9

BLT BLS SHD MHD	MHD	BLT BMT BLS OAK SHD MHD
SHD-106-433-1 2236	MHD-106-430-1P 2236	BMT-106-433-2 2236
BLT	BLT BMT BLS OAK SHD MHD	BLT BLS OAK SHD MHD
BLT-106-430-3 2236	MHD-122-433-X 2264	SHD-135-430-4 2210 sun
BLT BLS	BLT BMT BLS OAK SHD MHD	BLT BMT BLS OAK SHD MHD
BLT-135-433-6 2210 sun	BLTSL-152-430-X 764	MHDSL-129-430-1 836

BELLEVILLE® MAHOGANY TEXTURED with Glace™ glass BMT-152-430-X

BELLEVILLE® MAHOGANY TEXTURED with Glace™ glass BMT-129-430-X

classic designs

- BLT Belleville® Oak Textured
- BMT Belleville® Mahogany Textured
- BLS Belleville® Smooth
- OAK Oakcraft®
- SHD Sta-Tru® HD Steel
- MHD Masonite® HD Steel

BELLEVILLE® SMOOTH with Glace™ glass BLS-135-430-6

Glace™ 430brass 433platinum

6'8" configurations: 106-430-1, 106-430-1P, 106-430-2, 106-430-3, 122-430-X, 135-430-4, 135-430-6, 129-430-1, 152-430-X

8'0" configurations: 122-430-1, 122-430-2, 152-430-1, 122-433-1, 122-433-2

brass 430caming
platinum 433caming

All color images of doors represent 6'8" configurations. See line art chart for 8'0" door configurations. For specific door availability, please refer to charts on pages 96-98.



BELLEVILLE® MAHOGANY TEXTURED with Chandler™ glass door BMT-106-551-2 - sidelite BMTSL-152-551-X

black chrome 551caming



Least Obscure **PRIVACY RATING** Most Obscure
 1 2 3 4 5 6 **7** 8 9

- BLT Belleville® Oak Textured
- BMT Belleville® Mahogany Textured
- BLS Belleville® Smooth
- OAK Oakcraft®
- SHD Sta-Tru® HD Steel
- MHD Masonite® HD Steel

Chandler™ 551blackchrome 553nickel



All color images of doors represent 6'8" configurations. See line art chart for 8'0" door configurations. For specific door availability, please refer to charts on pages 96-98.

chandler
 GLASS

- BLS-106-551-1 2236
- MHD-106-553-1P 2236
- BMT-106-551-2 2236
- BLT-106-553-3 2236
- SHD-120-553-X 2064
- BMT-122-551-X 2264
- BMT-404-551-1 2248
- MHDSL-450-553-1 848
- BMTSL-152-551-X 764
- BLSSL-129-551-1 836

HD STEEL with Chandler™ glass MHD-106-551-1P

BLT
 BLS
 OAK
 SHD
 MHD

BLT-404-553-2 2248

BLT
 BMT
 BLS
 OAK
 SHD
 MHD

BMT-404-553-2 2248

beautiful appearances

oxford
GLASS



HD STEEL with Oxford™ glass – door MHD-106-137-1P

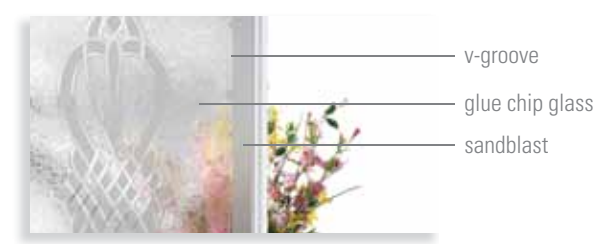

v-groove
glue chip glass
sandblast



- BLT Belleville® Oak Textured
- BMT Belleville® Mahogany Textured
- BLS Belleville® Smooth
- OAK Oakcraft®
- SHD Sta-Tru® HD Steel
- MHD Masonite® HD Steel

Oxford™ 137v-groove

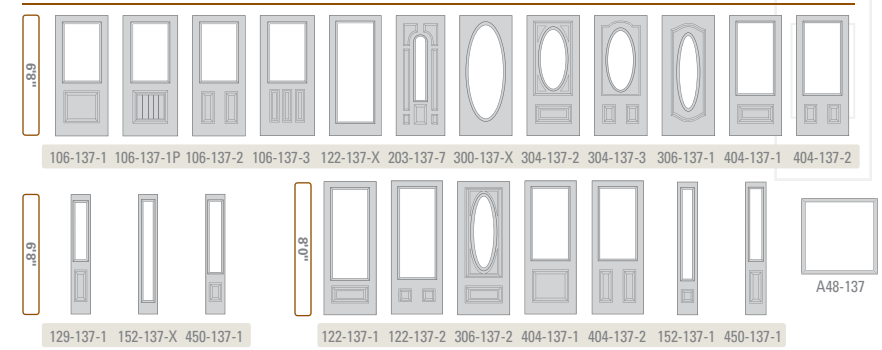

All color images of doors represent 6'8" configurations. See line art chart for 8'0" door configurations. For specific door availability, please refer to charts on pages 96-98.

BLT BLS SHD MHD BLS-106-137-1 2236

MHD MHD-106-137-1P 2236

BLT BMT BLS OAK SHD MHD BLS-106-137-2 2236

BLT BLS BLS-106-137-3 2236

HD STEEL with Oxford™ glass MHD-304-137-3

BLT BMT BLS OAK SHD MHD BLS-122-137-X 2264

BLT BLS SHD MHD BLS-203-137-7 842 round-top

BLT BLS OAK SHD MHD SHD-300-137-X 2057 oval

BMT BMT-304-137-2 1640 oval

BLT BMT BLS OAK SHD MHD MHD-304-137-3 1640 oval

BLT BLS OAK SHD MHD BLS-404-137-2 2248

BLT BMT BLS OAK SHD MHD BMTSL-450-137-1 848

BLT BMT BLS OAK SHD MHD BMTSL-152-137-X 764

BLT BMT BLS OAK SHD MHD MHDSL-129-137-1 836

BMT BMT-404-137-1 2248

BLT SHD MHD BLS-306-137-1 1555 oval





HD STEEL with Blinds MHD-B122-01RL-X

- BLT Belleville® Oak Textured
- BMT Belleville® Mahogany Textured
- BLS Belleville® Smooth
- OAK Oakcraft®
- SHD Sta-Tru® HD Steel
- MHD Masonite® HD Steel



InternalBlinds 010 tilonly 01RL raise&lower-tilt

Imagine a blind you don't have to dust or clean. Our blinds are built-into efficient sealed units protected with tempered glass. A single touch easily opens/closes blinds for privacy and light exposure.

	B106-010-2 B106-01RL-2	B106-09E'-2 -	B120-010-X B120-01RL-X	B122-010-X B122-01RL-X	B120-150E'-X -	B122-150E'-X -	B160-010-2 B160-01RL-2	B404-010-2 -	B129-010-1 -	B152-010-X -	B450-010-1 -	B810-010-X B810-01RL-X	B820-010-X B820-01RL-X
BLT	•	•	•	•	•	•	•	•	•	•	•	•	•
BMT*	-	-	-	-	-	-	-	-	-	-	-	-	-
BLS	•	•	•	•	•	•	•	•	•	•	•	•	•
OAK	•	•	•	•	•	•	•	•	•	•	•	•	•
SHD	•	•	•	•	•	•	•	•	•	•	•	•	•
MHD	•	•	•	•	•	•	•	•	•	•	•	•	•
MUS	•	•	•	•	•	•	•	•	•	•	•	•	•

VentingInserts 010onelite | standard internalgrille | clearglass

Our venting inserts are virtually maintenance free and will not yellow or crack.

	V106-010'-2	V120-010'-X	V122-010'-X	V160-010'-2	V404-010'-2	V129-010'-1	V151-010'-X	V106-121'-2	V120-181'-X	V122-181'-X	V160-121'-2	V404-121'-2	V129-041'-1	V151-061'-X
BLT	•	•	•	•	•	•	•	•	•	•	•	•	•	•
BMT*	-	-	-	-	-	-	-	-	-	-	-	-	-	-
BLS	•	•	•	•	•	•	•	•	•	•	•	•	•	•
OAK	•	•	•	•	•	•	•	•	•	•	•	•	•	•
SHD	•	•	•	•	•	•	•	•	•	•	•	•	•	•
MHD	•	•	•	•	•	•	•	•	•	•	•	•	•	•
MUS	•	•	•	•	•	•	•	•	•	•	•	•	•	•

ExternalGrilleInserts E standard externalgrille** | clearglass

	105-11E'-2	106-09E-2	107-09E-2	120-10E'-X	122-10E'-X	120-15E-X	122-15E-X	133-05E'-4	135-05E-4	137-05E-4	160-09E-2	822-04E-4	129-03E-1	152-05E-X	200-03E'-1	810-18E'-X
BLT	•	•	•	•	•	•	•	•	•	•	•	•	•	•	•	•
BMT*	-	-	-	-	-	-	-	-	-	-	-	-	-	-	-	-
BLS	•	•	•	•	•	•	•	•	•	•	•	•	•	•	•	•
OAK	•	•	•	•	•	•	•	•	•	•	•	•	•	•	•	•
SHD	•	•	•	•	•	•	•	•	•	•	•	•	•	•	•	•
MHD	•	•	•	•	•	•	•	•	•	•	•	•	•	•	•	•
MUS	•	•	•	•	•	•	•	•	•	•	•	•	•	•	•	•

MHD and SHD doors are available with Wood-Edge or Steel-Edge construction. MUS doors are Wood-Edge only. Wood-Edge sidelites are utilized on all MUS, MHD and SHD door units.
 *Almond stainable frames are not available. *Mahogany tinted frames are not available, however, BMT doors are physically compatible with BLT inserts.
 **Simulated divided lite options using extruded PVC lineals are available in select configurations.

clear lites clearglass

OneLite 010 standard onelite

	105-010-2	106-010-2	107-010-2	108-010'-X	109-010-X	114'-010-X	120-010-X	122-0101-X	135-010-4	136-010-8	137-010-4	160-010'-2	228-010-4
BLT	•	•	•	•	•	•	•	•	•	-	•	•	
BMT*	-	-	-	-	-	-	-	-	-	-	-	-	
BLS	•	•	•	•	•	•	•	•	•	-	•	•	
OAK	•	•	•	•	•	•	•	•	•	•	•	•	
SHD	•	•	•	•	•	•	•	•	•	•	•	•	
MHD	•	•	•	•	•	•	•	•	•	•	•	•	
MUS	•	•	•	•	•	-	•	•	•	-	•	•	

	300-010-X	304-010-3	404-010-2	410-010-2	680-010-4	129-010-1	149-010'-X	152-010-X	200-010-1	450-010-1	810-010-X	820-010-X	852-010-X
BLT	•	•	•	•	-	•	•	•	•	•	•	•	•
BMT*	-	-	-	-	-	-	-	-	-	-	-	-	-
BLS	•	•	•	•	-	•	•	•	•	•	•	•	•
OAK	•	•	•	•	-	•	•	•	•	•	•	•	•
SHD	•	•	•	•	-	•	•	•	•	•	•	•	•
MHD	•	•	•	•	-	•	•	•	•	•	•	•	•
MUS	•	-	-	-	•	•	•	•	•	-	-	-	-

InternalGrilleInserts | standard internalgrille | P prairie internalgrille | clearglass

	105-111-2	106-091-2	107-091-2	109-171-X	114-101-X	120-101-X	122-101-X	120-151-X	122-151-X	135-051-4	160-091-2	228-061-4	404-121-2
BLT	•	•	•	•	•	•	•	•	•	•	•	•	•
BMT*	-	-	-	-	-	-	-	-	-	-	-	-	-
BLS	•	•	•	•	•	•	•	•	•	•	•	•	•
OAK	•	•	•	•	•	•	•	•	•	•	•	•	•
SHD	•	•	•	•	•	•	•	•	•	•	•	•	•
MHD	•	•	•	•	•	•	•	•	•	•	•	•	•
MUS	•	•	•	•	•	•	•	•	•	•	•	•	•

	129-031-1	152-051-X	200-031-1	450-041-1	810-121-X	820-121-X	810-181-X	820-181-X	852-061-X	106-09P-2	120-09P-X	122-09P-X	160-09P-2	129-06P-1	152-06P-X
BLT	•	•	•	•	•	•	•	•	•	•	•	•	•	•	•
BMT*	-	-	-	-	-	-	-	-	-	-	-	-	-	-	-
BLS	•	•	•	•	•	•	•	•	•	•	•	•	•	•	•
OAK	•	•	•	•	•	•	•	•	•	•	•	•	•	•	•
SHD	•	•	•	•	•	•	•	•	•	•	•	•	•	•	•
MHD	•	•	•	•	•	•	•	•	•	•	•	•	•	•	•
MUS	•	•	•	•	•	•	•	•	•	•	•	•	•	•	•

Internal Grille Types
 (specify grille type when ordering)
 All grille styles are not available in all lite sizes. See price book for detailed offering list.

- A** White Slimline 1/4" x 5/16"
- B** White Traditional 1/4" x 5/8"
- C** White Wide Traditional 3/8" x 7/8"
- D** White Georgian 5/16" x 5/8"
- E** Sandalwood Traditional 1/4" x 5/8"
- G** Brass Slimline 1/4" x 5/16"
- H** Tudor 1/4" x 5/8"
- M** Antique Black 1/4" x 5/8"

MHD and SHD doors are available with Wood-Edge or Steel-Edge construction. MUS doors are Wood-Edge only. Wood-Edge sidelites are utilized on all MUS, MHD and SHD door units.
 † Almond stainable frames are not available. *Mahogany tinted frames are not available, however, BMT doors are physically compatible with BLT inserts.

flush-glazed doors

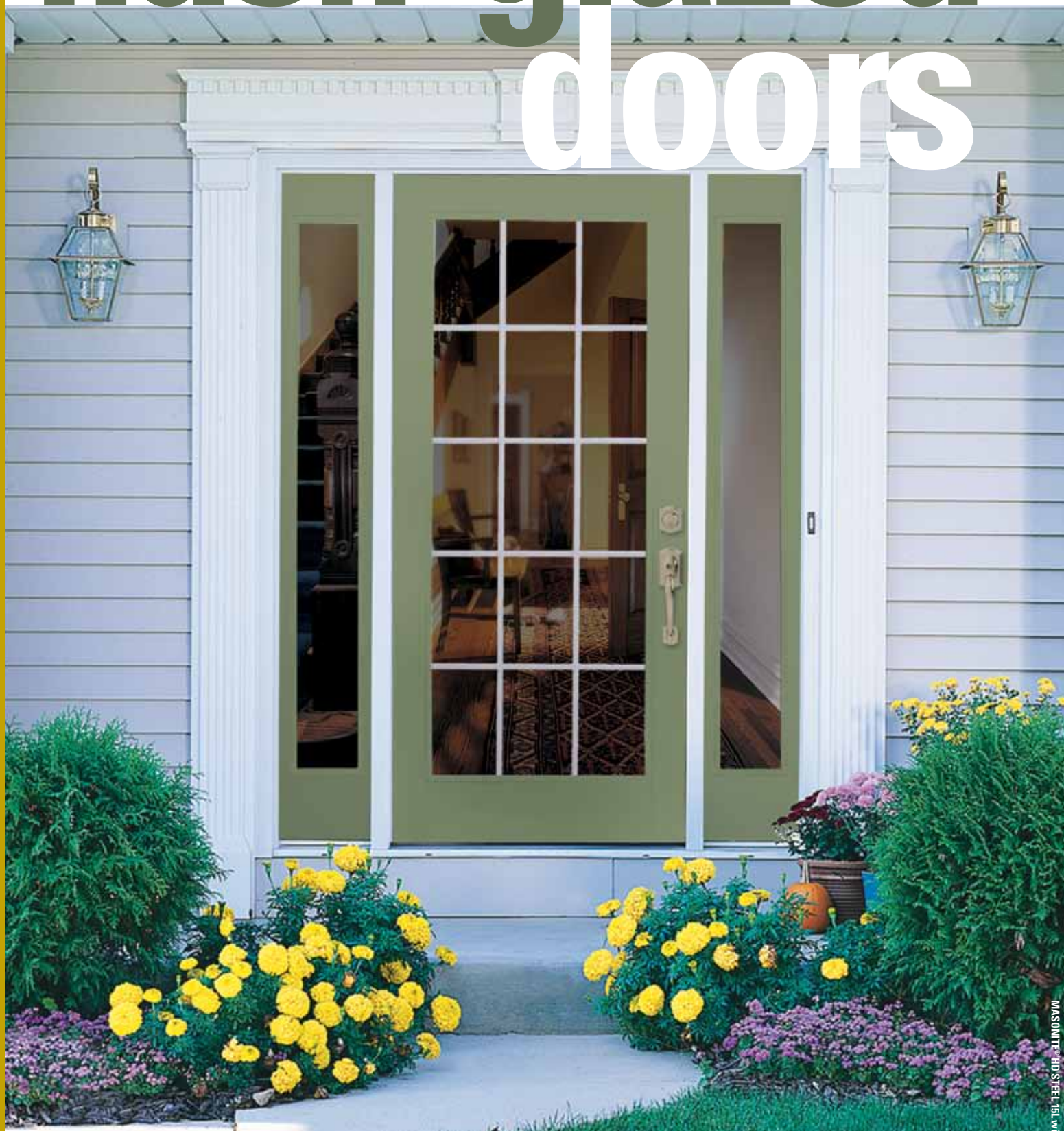

MASONITE® HD STEEL 15L with clear glass

Masonite®
FLUSH-GLAZED DOORS

smooth & textured fiberglass

LIMITED 25 YEAR WARRANTY

factory-glazed options



6'-8" DOORS

half lite clear and half lite low-e clear
9 lite clear grille between glass and 9 lite clear low-e grille between glass
1 lite clear and 1 lite low-e clear
1 lite clear and 1 lite low-e clear
1 lite internal mini-blind
1 lite internal mini-blind



steel
LIMITED 5 YEAR WARRANTY



6'-8" DOORS

8'-0" DOORS

15 lite grille between glass
15 lite grille between glass
18 lite grille between glass
18 lite grille between glass

Outstanding Aesthetics

- ✓ glazing bead is flush with the surface of the door, no screw holes or plugs
- ✓ provides a much cleaner appearance

Engineered Durability & Energy Efficient

- ✓ incorporates cutting-edge fiberglass or steel technology for durability
- ✓ insulated core for improved energy efficiency
- ✓ low-e glass available

Stile & Rail Facing Construction

- ✓ features authentic stile & rail facing construction
- ✓ replicates the appearance of a real wood door without the maintenance

Wider Viewing Area

- ✓ 2'8" and 3'0" full lite units are available with up to 20% wider viewing area

Superior Strength

- ✓ full lite has reinforced construction with heavy-duty PVC insert
- ✓ unsurpassed strength and durability

available sizes & designs

LOW-E COATING IS ON SURFACE #3
NOTE: INTERNAL MINI-BLINDS ARE A TILT ONLY FUNCTION

glass widths	door panel (width x height)										sidelite panel (width x height)			
	20" x 6'8"	20" x 8'0"	26" x 6'8"	26" x 8'0"	28" x 6'8"	28" x 8'0"	21'0" x 6'8"	21'0" x 8'0"	30" x 6'8"	30" x 8'0"	10" x 6'8"	10" x 8'0"	12" x 6'8"	12" x 8'0"
7"	-	-	-	-	-	-	-	-	-	-	■*	■**	■**	■**
14"	●	●	-	-	-	-	-	-	-	-	-	-	-	-
20"	-	-	●■✓	●■✓	●■✓	●■✓	-	-	-	-	-	-	-	-
22"	-	-	-	-	●■✓	●■✓	●■✓	●■✓	●■✓	●■✓	-	-	-	-
26"	-	-	-	-	-	-	-	-	●■✓	●■✓	-	-	-	-
Half Lite Only†	-	-	-	-	●	-	●	-	●	-	-	-	-	-

Notes: ● = Smooth Fiberglass ■ = Textured Fiberglass ✓ = Steel ◆ = Glass insert required is a non-standard width (7" x 80") † = Half Lite is 1" glass only and not available "open" (no glass).
* = Not available factory-glazed, offered as OPEN PANEL ONLY. Masonite Full Lite Flush-Glazed Door Panels are also available "open" with stops available for 1" insulated glass insert.
Grilles between glass are 5/8" x 1/4" rectangular bar (white). Internal Mini-Blinds are not available in 8'0" height.

entry systems



- 1 Continuous Head, Sill and Mull System**
 - ✓ maximizes the stability and rigidity of any sidelited unit
 - ✓ simplifies assembly
 - ✓ virtually eliminates racking and bending
- 2 Exterior Frame System**
 - ✓ primed wood frames and applied brickmould are standard
 - ✓ other frame depths, stainable frames, vinyl-clad frames, and PVC brickmould are available
- 3 High-Performance Weather-stripping**
 - ✓ vinyl-wrapped, foam-filled, compression weather-stripping and corner seals are added to the door frame providing protection against air and water infiltration
- 4 High-Dam Adjustable Sill**
 - ✓ combining high-dam technology with a high-quality door bottom seal, securely protects bottom of door unit from air and water infiltration
 - ✓ adjustable cap permits easy field adjustments
 - ✓ composite materials protect against rot and harsh weather conditions

BELLEVILLE® SMOOTH with Quarto™ glass door BLS-106-957-1 sidelite BLSL-129-957-1



NOTE: Mill finish is standard on all sills. Brass or bronze finishes are also available.

door handing

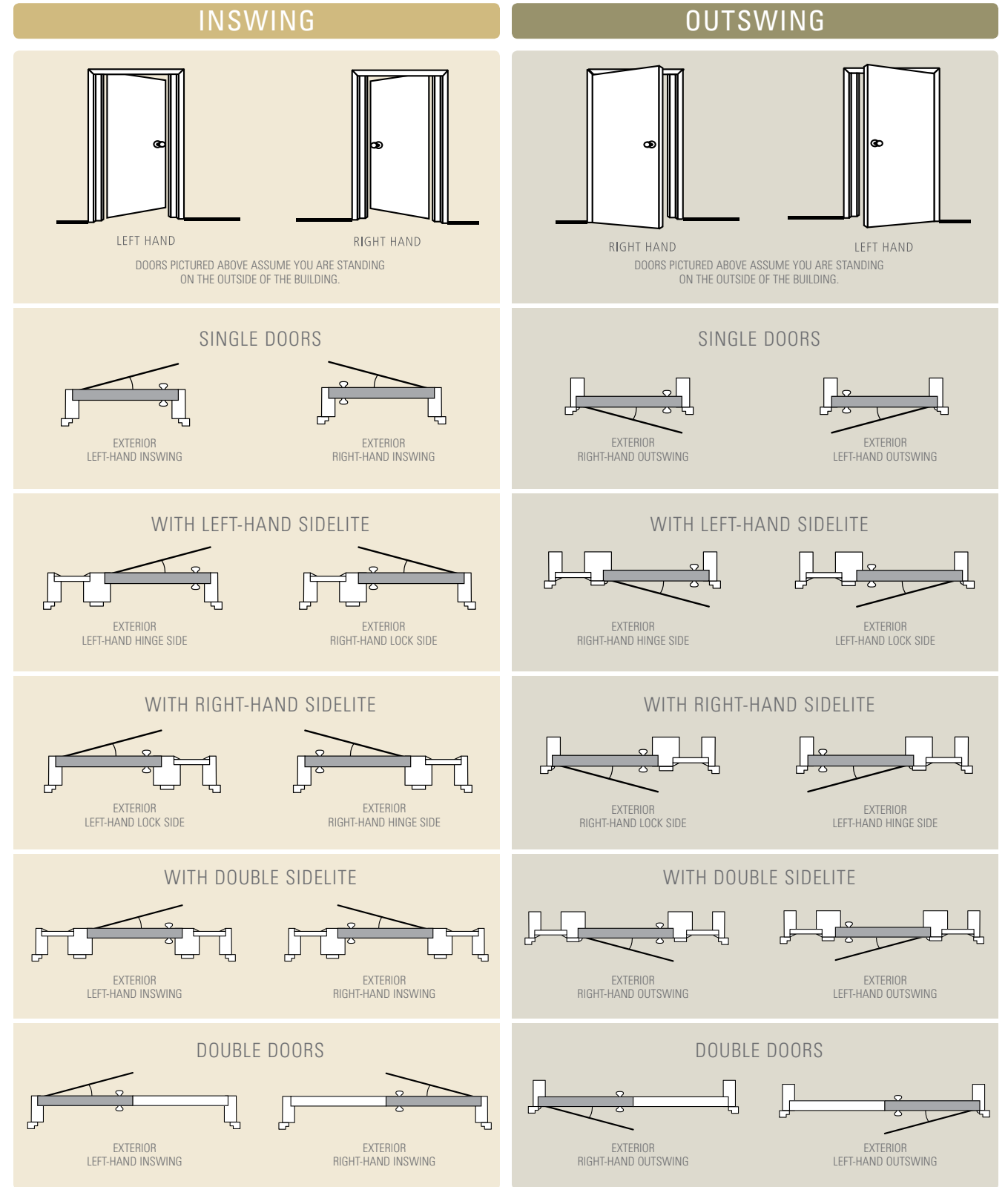

configurations

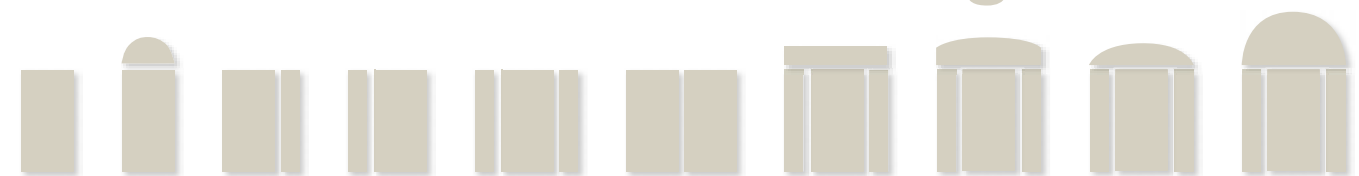

entry systems

rough openings

new construction size

SINGLE DOOR

Nominal Door Size		Door Unit Actual Size		Rough Opening Size (wood stud)		Outside Brickmould Size	
Width	Height	Width	Height	Width	Height	Width	Height
2'6"	6'8"	31-1/2"	81-1/2"	32-1/4"	82"	34"	82-3/4"
2'8"	6'8"	33-1/2"	81-1/2"	34-1/4"	82"	36"	82-3/4"
2'8"	8'0"	33-1/2"	97-1/2"	34-1/4"	98"	36"	98-3/4"
3'0"	6'8"	37-1/2"	81-1/2"	38-1/4"	82"	40"	82-3/4"
3'0"	8'0"	37-1/2"	97-1/2"	38-1/4"	98"	40"	98-3/4"

All dimensions shown are for inswing doors – deduct 1-1/8" from the actual door size, the rough opening size and the outside brickmould size height for outswing or handicap accessible doors. See product selection detailed in the Catalog to determine if the entry door style you have selected is available. Recommended rough openings for the FAST-FRAME™ adjustable steel frame offering are different than the dimensions shown in this chart – see rough opening chart titled FAST-FRAME. Floor covering can affect rough opening heights.

SINGLE DOOR WITH ONE L/H OR R/H SIDELITE

Nominal Door Size		Nominal Sidelite Size		Door Unit Actual Size		Rough Opening Size (wood stud)		Outside Brickmould Size	
Width	Height	Width	Height	Width	Height	Width	Height	Width	Height
2'6"	6'8"	10"	6'8"	43"	81-1/2"	43-3/4"	82"	45-1/2"	82-3/4"
2'6"	6'8"	1'0"	6'8"	45"	81-1/2"	45-3/4"	82"	47-1/2"	82-3/4"
2'6"	6'8"	1'2"	6'8"	47"	81-1/2"	47-3/4"	82"	49-1/2"	82-3/4"
2'8"	6'8"	10"	6'8"	45"	81-1/2"	45-3/4"	82"	47-1/2"	82-3/4"
2'8"	6'8"	1'0"	6'8"	47"	81-1/2"	47-3/4"	82"	49-1/2"	82-3/4"
2'8"	6'8"	1'2"	6'8"	49"	81-1/2"	49-3/4"	82"	51-1/2"	82-3/4"
2'8"	8'0"	1'0"	8'0"	47"	97-1/2"	47-3/4"	98"	49-1/2"	98-3/4"
2'8"	8'0"	1'2"	8'0"	49"	97-1/2"	49-3/4"	98"	51-1/2"	98-3/4"
3'0"	6'8"	10"	6'8"	49"	81-1/2"	49-3/4"	82"	51-1/2"	82-3/4"
3'0"	6'8"	1'0"	6'8"	51"	81-1/2"	51-3/4"	82"	53-1/2"	82-3/4"
3'0"	6'8"	1'2"	6'8"	53"	81-1/2"	53-3/4"	82"	55-1/2"	82-3/4"
3'0"	8'0"	1'0"	8'0"	51"	97-1/2"	51-3/4"	98"	53-1/2"	98-3/4"
3'0"	8'0"	1'2"	8'0"	53"	97-1/2"	53-3/4"	98"	55-1/2"	98-3/4"

All dimensions shown are for inswing doors – deduct 1-1/8" from the actual door size, the rough opening size and the outside brickmould size height for outswing or handicap accessible doors. See product selection detailed in the Catalog to determine if the entry door style you have selected is available. Floor covering can affect rough opening heights.

SINGLE DOOR WITH TWO SIDELITES

Nominal Door Size		Nominal Sidelite Size		Door Unit Actual Size		Rough Opening Size (wood stud)		Outside Brickmould Size	
Width	Height	Width	Height	Width	Height	Width	Height	Width	Height
2'6"	6'8"	10"	6'8"	54-1/2"	81-1/2"	55-1/4"	82"	57"	82-3/4"
2'6"	6'8"	1'0"	6'8"	58-3/8"	81-1/2"	59-1/8"	82"	60-7/8"	82-3/4"
2'6"	6'8"	1'2"	6'8"	62-3/8"	81-1/2"	63-1/8"	82"	64-7/8"	82-3/4"
2'8"	6'8"	10"	6'8"	56-1/2"	81-1/2"	57-1/4"	82"	59"	82-3/4"
2'8"	6'8"	1'0"	6'8"	60-3/8"	81-1/2"	61-1/8"	82"	62-7/8"	82-3/4"
2'8"	6'8"	1'2"	6'8"	64-3/8"	81-1/2"	65-1/8"	82"	66-7/8"	82-3/4"
2'8"	8'0"	1'0"	8'0"	60-3/8"	97-1/2"	61-1/8"	98"	62-7/8"	98-3/4"
2'8"	8'0"	1'2"	8'0"	64-3/8"	97-1/2"	65-1/8"	98"	66-7/8"	98-3/4"
3'0"	6'8"	10"	6'8"	60-1/2"	81-1/2"	61-1/4"	82"	63"	82-3/4"
3'0"	6'8"	1'0"	6'8"	64-3/8"	81-1/2"	65-1/8"	82"	66-7/8"	82-3/4"
3'0"	6'8"	1'2"	6'8"	68-3/8"	81-1/2"	69-1/8"	82"	70-7/8"	82-3/4"
3'0"	8'0"	1'0"	8'0"	64-3/8"	97-1/2"	65-1/8"	98"	66-7/8"	98-3/4"
3'0"	8'0"	1'2"	8'0"	68-3/8"	97-1/2"	69-1/8"	98"	70-7/8"	98-3/4"

All dimensions shown are for inswing doors – deduct 1-1/8" from the actual door size, the rough opening size and the outside brickmould size height for outswing handicap accessible doors. See product selection detailed in the Catalog to determine if the entry door style you have selected is available. Floor covering can affect rough opening heights.

Rough opening for units with transoms:

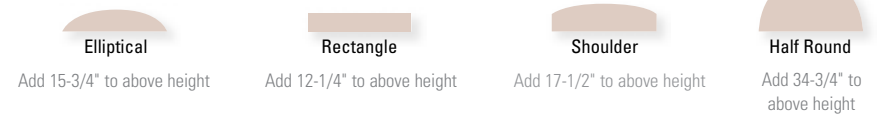

DOUBLE DOOR

Nominal Door Size		Door Unit Actual Size		Rough Opening Size (wood stud)		Outside Brickmould Size	
Width	Height	Width	Height	Width	Height	Width	Height
5'0"	6'8"	62"	81-1/2"	62-3/4"	82"	64-1/2"	82-3/4"
5'4"	6'8"	66"	81-1/2"	66-3/4"	82"	68-1/2"	82-3/4"
5'4"	8'0"	66"	97-1/2"	66-3/4"	98"	68-1/2"	98-3/4"
6'0"	6'8"	74"	81-1/2"	74-3/4"	82"	76-1/2"	82-3/4"
6'0"	8'0"	74"	97-1/2"	74-3/4"	98"	76-1/2"	98-3/4"

All dimensions shown are for inswing doors – deduct 1-1/8" from the actual door size, the rough opening size and the outside brickmould size height for outswing handicap accessible doors. See product selection detailed in the Catalog to determine if the entry door style you have selected is available. Recommended rough openings for the FAST-FRAME™ adjustable steel frame offering are different than the dimensions shown in this chart – see rough opening chart titled FAST-FRAME. Floor covering can affect rough opening heights.

Masonite patio doorsystems



LIMITED
25
YEAR
WARRANTY

Masonite Wood-Grain Textured Fiberglass Patio Doors

flush-glazed

standard-glazed

CONSTRUCTION FEATURES

- 1 white textured fiberglass facings
- 2 flush-glazed or standard lite inserts available
- 3 authentic stile & rail appearance
- 4 tempered, insulated glass

MASONITE® Wood-grain textured Fiberglass 15 lite patio

features



- 1 Frames**
 - ✓ Standard: 4-9/16" primed wood frames with brickmould
 - ✓ Optional 6-9/16" primed wood frames or maintenance free PVC frames in either width are available
- 2 Glass**
 - ✓ 5 flush-glazed glass options available
 - ✓ 4 standard-glazed options available
- 3 Square-Edge Construction**
 - ✓ fiberglass doors feature a square-edge design that provides easy hardware installation and wood door appearance
 - ✓ double-bore standard on both steel and fiberglass
- 4 High-Dam Thresholds**
 - ✓ inswing units feature a high-dam, adjustable, composite cap threshold which protects the bottom of the patio unit from air and water infiltration (outswing units utilize a bumper sill system)
- 5 Optional Screens**
 - ✓ constructed with white frames and fiberglass mesh
 - ✓ includes a roll formed steel frame and four adjustable nylon rollers

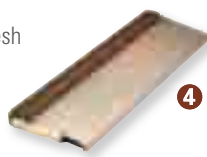

LIMITED
25
YEAR
WARRANTY

Masonite Smooth Fiberglass Patio Doors

- CONSTRUCTION FEATURES
- 1 smooth fiberglass facings
 - 2 standard glazing only
 - 3 authentic stile & rail appearance
 - 4 tempered, insulated glass



Masonite Wood-Edge Steel Patio Doors

LIMITED
5
YEAR
WARRANTY

- CONSTRUCTION FEATURES
- 1 galvanized steel facings
 - 2 flush-glazed or standard lite inserts available
 - 3 authentic stile & rail facing construction (flush-glazed)
 - 4 tempered, insulated glass



options

flush-glazed & standard-glazed (lite insert)
textured fiberglass or wood-edge steel textured fiberglass, smooth fiberglass or wood-edge steel



Note: All 1/2" thick clear glass, except mini-blind which is 1"

Note: All 1" thick clear glass, 5/8" rectangular white muntin bars on GBG

Masonite patio systems

rough openings & handing

systems



rough openings retro-fit size



DOUBLE (FRENCH) DOOR

Nominal Door Size		Actual Door Unit Size		Rough Opening Size (wood stud)		Outside Brickmould Size	
Width	Height	Width	Height	Width	Height	Width	Height
5'0"	6'8"	59-1/4"	79-1/2"	60"	80"	61-3/4"	80-3/4"
5'0"	8'0"	59-1/4"	95-1/2"	60"	96"	61-3/4"	96-3/4"
6'0"	6'8"	71-1/4"	79-1/2"	72"	80"	73-3/4"	80-3/4"
6'0"	8'0"	71-1/4"	95-1/2"	72"	96"	73-3/4"	96-3/4"

All dimensions shown are for inswing doors – deduct 1-1/4" from the actual door unit height, the rough opening height and the outside brickmould height for outswing doors. Width dimensions for active units reflect French door sizes. Floor covering can affect rough opening heights. All dimensions listed have a tolerance of +/- 3/16".



TRIPLE (FRENCH) DOOR

Nominal Door Size		Actual Door Unit Size		Rough Opening Size (wood stud)		Outside Brickmould Size	
Width	Height	Width	Height	Width	Height	Width	Height
9'0"	6'8"	107-5/16"	79-1/2"	108-1/16"	80"	109-13/16"	80-3/4"

All dimensions shown are for inswing doors – deduct 1-1/4" from the actual door unit height, the rough opening height and the outside brickmould height for outswing doors. Floor covering can affect rough opening heights. All dimensions listed have a tolerance of +/- 3/16".



DOUBLE (CENTER-SWING) DOOR

Nominal Door Size		Actual Door Unit Size		Rough Opening Size (wood stud)		Outside Brickmould Size	
Width	Height	Width	Height	Width	Height	Width	Height
5'0"	6'8"	59-3/4"	79-1/2"	60-1/2"	80"	62-1/4"	80-3/4"
5'0"	8'0"	59-3/4"	95-1/2"	60-1/2"	96"	62-1/4"	96-3/4"
6'0"	6'8"	71-3/4"	79-1/2"	72-1/2"	80"	74-1/4"	80-3/4"
6'0"	8'0"	71-3/4"	95-1/2"	72-1/2"	96"	74-1/4"	96-3/4"

All dimensions shown are for inswing doors – deduct 1-1/4" from the actual door unit height, the rough opening height and the outside brickmould height for outswing doors. Width dimensions for active units reflect French door sizes. Floor covering can affect rough opening heights. All dimensions listed have a tolerance of +/- 3/16".



TRIPLE (CENTER-SWING) DOOR

Nominal Door Size		Actual Door Unit Size		Rough Opening Size (wood stud)		Outside Brickmould Size	
Width	Height	Width	Height	Width	Height	Width	Height
9'0"	6'8"	107-13/16"	79-1/2"	108-9/16"	80"	110-5/16"	80-3/4"

All dimensions shown are for inswing doors – deduct 1-1/4" from the actual door unit height, the rough opening height and the outside brickmould height for outswing doors. Floor covering can affect rough opening heights. All dimensions listed have a tolerance of +/- 3/16".

handing chart

INSWING

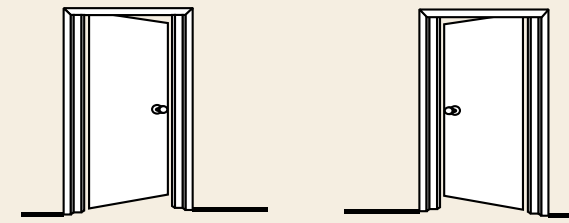

LEFT HAND RIGHT HAND

DOORS PICTURED ABOVE ASSUME YOU ARE STANDING ON THE OUTSIDE OF THE BUILDING.

OUTSWING

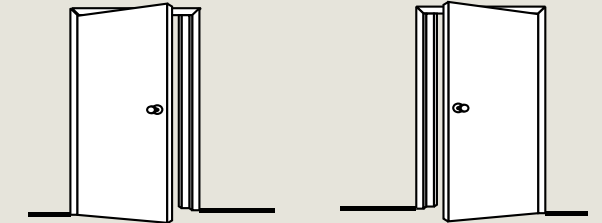

RIGHT HAND LEFT HAND

DOORS PICTURED ABOVE ASSUME YOU ARE STANDING ON THE OUTSIDE OF THE BUILDING.

FRENCH SINGLE DOORS

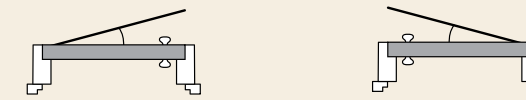

EXTERIOR LEFT-HAND INSWING EXTERIOR RIGHT-HAND INSWING

FRENCH SINGLE DOORS



EXTERIOR RIGHT-HAND OUTSWING EXTERIOR LEFT-HAND OUTSWING

FRENCH DOUBLE DOORS

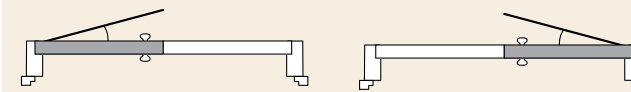

EXTERIOR LEFT-HAND INSWING EXTERIOR RIGHT-HAND INSWING

FRENCH DOUBLE DOORS

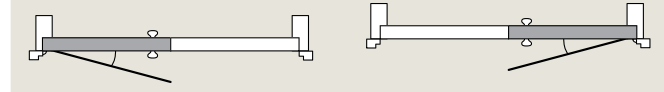

EXTERIOR RIGHT-HAND OUTSWING EXTERIOR LEFT-HAND OUTSWING

CENTER-HINGE DOUBLE DOORS

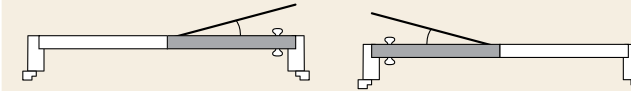

EXTERIOR LEFT-HAND INSWING EXTERIOR RIGHT-HAND INSWING

CENTER-HINGE DOUBLE DOORS

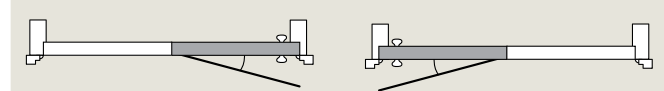

EXTERIOR RIGHT-HAND OUTSWING EXTERIOR LEFT-HAND OUTSWING

CENTER-HINGE TRIPLE DOORS

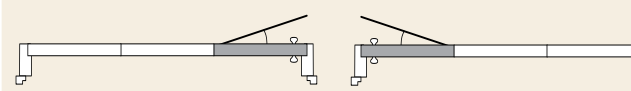

EXTERIOR LEFT-HAND INSWING EXTERIOR RIGHT-HAND INSWING

CENTER-HINGE TRIPLE DOORS

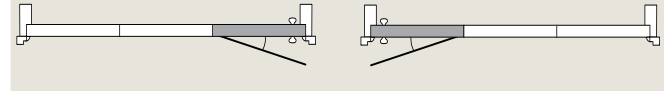

EXTERIOR RIGHT-HAND OUTSWING EXTERIOR LEFT-HAND OUTSWING

FIXED DOORS

SINGLE DOOR

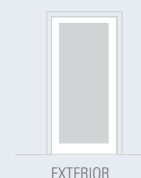

EXTERIOR

DOUBLE DOORS



EXTERIOR

TRIPLE DOORS

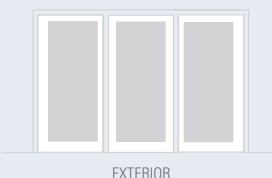

EXTERIOR

adjustable steel door frames

THE ULTIMATE ADJUSTABLE KERFED STEEL DOOR FRAME

FAST-FRAME's advanced design adds a new dimension of flexibility and durability to Masonite's steel entry door line. Developed and manufactured exclusively for Masonite by TIMELY®, FAST-FRAME™ features a full 1" of adjustability to accommodate almost any variation in wall construction. This easy-to-install, user-friendly, kerfed steel door frame system is applicable to a full range of residential and commercial applications – wood or steel stud construction. TIMELY's expertise in innovating and manufacturing steel door frame components is second to none. FAST-FRAME is engineered to meet the most stringent code requirements including structural, impact and 90-minute fire ratings.

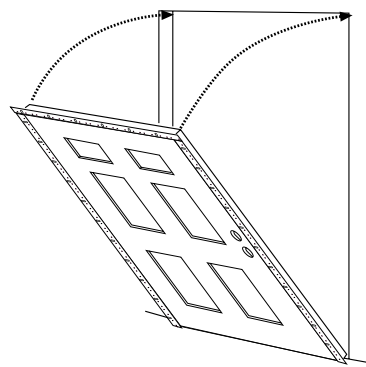

SILLS

Standard Inswing
Thermally broken – 5-5/8" width
Optional extenders for larger wall sizes
Note: Not for use on outswing applications.

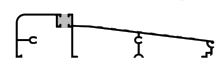

Handicap (ADA)

Double Slope 5" and 7" width

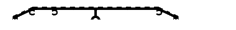

Tile Face 5" and 7" width

Note: Not for use on outswing applications.

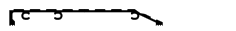

Bumper Outswing 4-1/2" width



TA-1 ADJUSTABLE T-STRIKE

1/4" of adjustment allows for ease of field installations for proper door closure

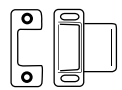

OUTER ADJUSTABLE CLOSURE

20-gauge steel
2 uprights – 1 header

CLOSURE SPAN ADJUSTMENT CHART

Wall Sizes	A
4-1/2" – 5-1/2" = 1-7/8"	
5-1/2" – 6-1/2" = 2-7/8"	
6-1/2" – 7-1/2" = 3-7/8"	

Wider sizes are available upon request.

WEATHERSTRIPPING

Schlegel foam-filled compression (QEBD500)
90-minute fire rating

PRIME BRIGHT WHITE EG

Galvanized 20-gauge steel provides superior corrosion resistance and an optimal surface for painting



- Double door width is with a "Z" astragal. If using a 5/8" astragal then add 9/16" to the width
- All dimensions shown are for doors with standard inswing sill. Deduct 13/16" for bumper outswing or handicap compliant sill
- Add 4" to height for 7'0" height
- Add 16" to height for 8'0" height
- Premdor spec slabs add 1/4" to height

FAST-FRAME™ Rough Openings

Prehung door sizes

	Nominal Door Size		Rough Opening Size (wood stud)	
	Width	Height	Width	Height
Single door	2'0"	6'8"	25-1/4"	81-3/8"
	2'6"	6'8"	31-1/4"	81-3/8"
	2'8"	6'8"	33-1/4"	81-3/8"
	2'10"	6'8"	35-1/4"	81-3/8"
	3'0"	6'8"	37-1/4"	81-3/8"
Double door	4'0"	6'8"	49-5/32"	81-3/8"
	5'0"	6'8"	61-5/32"	81-3/8"
	5'4"	6'8"	65-5/32"	81-3/8"
	5'8"	6'8"	69-5/32"	81-3/8"
	6'0"	6'8"	73-5/32"	81-3/8"

CASING OPTIONS



INTERIOR WOOD TRIM



EXTERIOR BRICKMOULD

Wood trim and brickmould can be easily applied to Fast-Frame using nails or trim head screws without the need for custom millwork.

FAST-FRAME CASINGS

TA-8 STANDARD STEEL CASING



TA-30 COLONIAL STEEL CASING



- TA-8 casings enhance any commercial or residential setting.
- TA-30 casings add a special warmth for assisted living, motels, hotels, offices, apartments and homes.

It is recommended that TA-18 retainer clips be used for both casings.

APPLICATIONS

- Multi-Family • Assisted Living • Motel/Hotel
- House to Garage • Garage to Exterior



FIRE LABELS

- 90-Minute Fire Rating
- up to 3'0" x 8'0" Single
- up to 6'0" x 7'0" Double

CLOSURE TEST

In a 90-minute application, the door will close and latch from 18" if the following Fast-Frame components are used:

- QEBD500 Foam-Filled Compression Weatherstripping
- Factory Sweep • Adjustable T-Strike • Factory Supplied Sills



STRUCTURAL PERFORMANCE AND IMPACT RATING

Design pressure ratings are available for compliance with national, state and local wind load and/or missile requirements. Product approval under the Miami-Dade BCCO NOA or Intertek Testing Services/Warlock Hersey® programs.

DOOR SELECTION

Fast-frame is available in either right- or left-hand inswing or outswing, and is for use with any Masonite steel entry door.

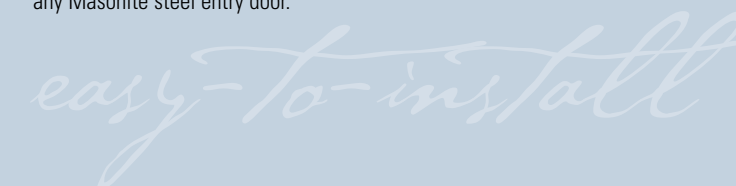

MASONITE™ HD 6 panel steel door



Masonite® steel door selection & style



STA-TRU® HD STEEL with Madrid® glass SHD-306-900-1

MASONITE® HD STEEL MHD 2 panel camber-top plank

touch of style

Masonite® High-Definition Steel door series

- Masonite® HD Steel unique features**
- factory-primed surface** super-tough, baked-on primer provides superior protection against the elements (finishing required)
 - high-definition panel profile** adds a touch of style and distinction and more closely replicates the appearance of a wood door
 - steel-edge or wood-edge construction**
 - composite bottom rail** creates a rot and moisture resistant structure
- 15 YEAR LIMITED WARRANTY (Steel-Edge)
5 YEAR LIMITED WARRANTY (Wood-Edge)
See page 28 for full door details.

	FLUSH	1 P ARCH	2 P CAMBER-TOP	2 P CAMBER-TOP PLANK	2 P W/ 23 X 65 C/O	3 P ARCH-TOP	4 P BLANK-TOP
6'8"	MHD 2'0", 2'6", 2'8" 2'10", 3'0"	MHD 2'8", 2'10" 3'0"	MHD 2'8", 2'10" 3'0"	MHD 2'8", 2'10" 3'0"	-	MHD 2'8", 2'10" 3'0"	MHD 2'6", 2'8" 2'10", 3'0"
7'0"	MHD 2'0", 2'6", 2'8" 2'10", 3'0"	-	-	-	-	-	MHD 2'6", 2'8" 2'10", 3'0"
8'0"	MHD 2'0", 2'6", 2'8" 2'10", 3'0"	-	-	-	MHD 2'8", 2'10" 3'0"	-	-
fire door option	MHD 2'0", 2'6", 2'8" 2'10", 3'0"	MHD 2'8", 2'10" 3'0"	MHD 2'8", 2'10" 3'0"	MHD 2'8", 2'10" 3'0"	-	MHD 2'8", 2'10" 3'0"	-
glass sizes	109, 120, 122 300, 810	306	106, 107	106, 107	122	304 404, 410	105, 106, 107 135, 137

	NEW ENGLAND	6 P	8 P PARLAMENT	9 P CAMBER-TOP	FLUSH SIDEITE	1 P SIDEITE w/ 9 X 65 C/O	2 P UNIVERSAL SIDEITE	3 P SIDEITE
6'8"	MHD 2'8", 2'10" 3'0"	MHD 2'6", 2'8" 2'10", 3'0"	MHD 2'8", 2'10" 3'0"	MHD 2'8", 2'10" 3'0"	MHD 10", 1'0", 1'2"	MHD -	MHD 1'0", 1'2"	MHD -
7'0"	-	MHD 2'6", 2'8" 2'10", 3'0"	-	-	MHD 1'0", 1'2"	-	MHD 1'0", 1'2"	-
8'0"	-	MHD 2'8", 2'10" 3'0"	-	-	MHD 1'0", 1'2"	MHD 1'0", 1'2"	-	MHD 1'0", 1'2"
fire door option	-	MHD 2'6", 2'8" 2'10", 3'0"	MHD 2'8", 2'10" 3'0"	MHD 2'8", 2'10" 3'0"	-	-	-	-
glass sizes	106	106, 120 122, 404, 810	203	136	149, 151 152, 852	151	129, 200, 450	450, 852

- Sta-Tru HD Steel unique features**
- prefinished white surface** factory applied white paint provides superior aesthetics and protection against the elements (no finishing required)
 - high-definition panel profile** adds a touch of style and distinction and more closely replicates the appearance of a wood door
 - steel-edge or wood-edge construction**
 - composite bottom rail** creates a rot and moisture resistant structure

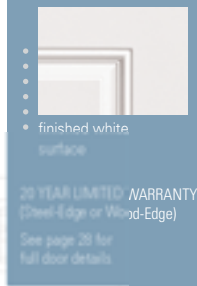

Masonite® Sta-Tru® HD Steel door series

	FLUSH	1 P ARCH	2 P CAMBER-TOP	2 P W/ 23 X 65 C/O	3 P ARCH-TOP	4 P BLANK-TOP	4 P NEW ENGLAND
6'8"	SHD 2'0", 2'6", 2'8" 2'10", 3'0"	SHD 2'8", 2'10" 3'0"	SHD 2'8", 2'10" 3'0"	-	SHD 2'8", 2'10" 3'0"	SHD 2'6", 2'8" 2'10", 3'0"	SHD 2'8", 2'10" 3'0"
7'0"	SHD 2'0", 2'6", 2'8" 2'10", 3'0"	-	-	-	-	SHD 2'6", 2'8" 2'10", 3'0"	-
8'0"	SHD 2'0", 2'6", 2'8" 2'10", 3'0"	-	-	SHD 2'8", 2'10" 3'0"	-	-	-
fire door option	SHD 2'0", 2'6", 2'8" 2'10", 3'0"	SHD 2'8", 2'10" 3'0"	SHD 2'8", 2'10" 3'0"	-	-	-	SHD 2'10", 3'0"
glass sizes	109, 120, 122 300, 810	306	106, 107	122	304 404, 410	105, 106, 107 135, 137	106

	6 P	8 P PARLAMENT	9 P CAMBER-TOP	FLUSH SIDEITE	1 P SIDEITE w/ 9 X 65 C/O	2 P UNIVERSAL SIDEITE	3 P SIDEITE
6'8"	SHD 2'6", 2'8" 2'10", 3'0"	SHD 2'8", 2'10" 3'0"	SHD 2'8", 2'10" 3'0"	SHD 10", 1'0", 1'2"	SHD -	SHD 1'0", 1'2"	SHD -
7'0"	SHD 2'6", 2'8" 2'10", 3'0"	-	-	SHD 1'0", 1'2"	-	SHD 1'0", 1'2"	-
8'0"	SHD 2'8", 2'10" 3'0"	-	-	SHD 10", 1'0", 1'2"	SHD 1'0", 1'2"	-	SHD 1'0", 1'2"
fire door option	SHD 2'6", 2'8" 2'10", 3'0"	SHD 2'8", 2'10" 3'0"	SHD 2'8", 2'10" 3'0"	-	-	-	-
glass sizes	106, 120 122, 404, 810	203	136	149, 151 152, 852	151	129, 200, 450	450, 852

Masonite® Utility Steel door series

- Masonite Utility Steel unique features**
- factory-primed surface** superior protection against the elements (finishing required)
 - standard panel profile**
 - wood-edge construction**
 - 26-gauge, galvanized, primed steel facings**
 - composite bottom rail** creates a rot and moisture resistant structure
- 1 YEAR LIMITED WARRANTY (Wood-Edge)
See page 28 for full door details.

	FLUSH	4 P BLANK-TOP	6 P	FLUSH SIDEITE	2 P SIDEITE
6'8"	MUS 2'6", 2'8" 2'10", 3'0"	MUS 2'6", 2'8" 2'10", 3'0"	MUS 2'6", 2'8" 2'10", 3'0"	MUS 10", 1'0", 1'2"	MUS 1'0", 1'2"
7'0"	-	-	-	-	-
8'0"	-	-	-	-	-
glass sizes	109, 120 122, 300	105, 106, 107 135, 137	106 120, 122	149, 151, 152	129, 200

- SHD Sta-Tru® HD Steel
- MHD Masonite® HD Steel
- MUS Masonite® Utility Steel



outstanding panel definition

† Features narrow panel layout. * Available in Wood-Edge only.
Available as Warnock-Hershey® listed fire door (Wood-Edge is 20-minute only in 6'8" and 7'0" heights, Steel-Edge is 90-minute in 6'8", 7'0" and 8'0" heights, Masonite® HD or Sta-Tru® HD only)

Barrington® selection & style

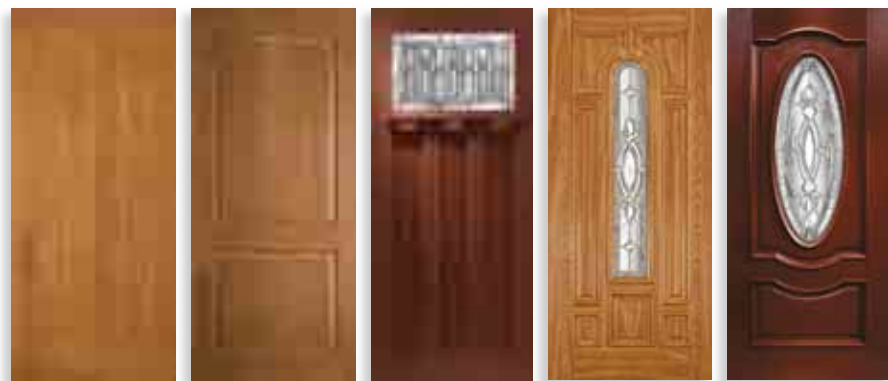

Barrington Traditional unique features

- oak or mahogany texture**
options reflect state-of-the-art, variable-depth authentic hardwood appearance that finishes easily and beautifully
- distinct raised moulding**
– integrated into the facing (no plant-on applique)
– reminiscent of hand-crafted hardwood doors
- proprietary decorative glass design**
options – BR1, BR2, or BR3
- custom glazing frames**
– match panel moulding
– architecturally correct alignment between glazing frame & panel moulding
- durability**
will not dent and resists splitting, cracking and warping

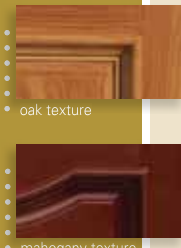

LIFETIME LIMITED WARRANTY
See page 12 for full door details.

Barrington® Traditional fiberglass door series

glass options	6'8" 3'0"	8'0" 3'0", 3'6"	6'8" 3'0"	8'0" 3'0", 3'6"	6'8" 3'0"	8'0" 3'0", 3'6"	6'8" 3'0"	8'0" 3'0", 3'6"	6'8" 1'0", 1'2"	8'0" 1'0", 1'2"	6'8" 1'0", 1'2"	8'0" 1'0", 1'2"		
BR1	204-BR1	205-BR1	301-BR1	–	303-BR1	302-BR1	405-BR1	123-BR1	411-BR1	412-BR1	154-BR1	853-BR1	451-BR1	153-BR1
BR2	204-BR2	205-BR2	301-BR2	–	303-BR2	302-BR2	405-BR2	123-BR2	411-BR2	412-BR2	154-BR2	853-BR2	451-BR2	153-BR2
BR3	204-BR3	205-BR3	301-BR3	–	303-BR3	302-BR3	405-BR3	123-BR3	411-BR3	412-BR3	154-BR3	853-BR3	451-BR3	153-BR3

compatible door unit sizes	1'0"- 3'0"- 1'0" & 1'2"- 3'0"- 1'2"				3'0"	
BR1 transoms	C-869	S-869	E-869	T-869	–	
BR2 transoms	–	S-900	E-900	T-900	C38-900	
BR3 transoms	C-725	S-725	E-725	T-725	C38-725	

custom glass options

- BR1 brass caming
- BR2 antique black caming
- BR3 platinum caming

BARRINGTON® CRAFTSMAN TEXTURED OAK with BC4 glass and applied dentil shelf BRC-225-BC4-3



Barrington Craftsman unique features

- oak or mahogany texture**
authentic hardwood options
- Mission/Craftsman style**
with three recessed panels
- custom glass**
options – BC4, BC5 or BS1
- factory-glazed with unique**
1 lite custom glazing system
- dentil shelf** option
- simulated divided lite kit (SDL)** option

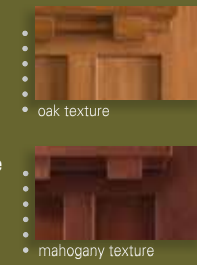

LIFETIME LIMITED WARRANTY
See page 16 for full door details.

Barrington® Craftsman fiberglass door series

compatible door unit sizes	1'0"- 3'0"- 1'0" & 1'2"- 3'0"- 1'2"	
BC4 transoms	–	T-366
BC5 transoms	S-315	T-315

compatible door unit sizes	1'0"- 3'0"- 1'0" & 1'2"- 3'0"- 1'2"	
BS1 transoms	–	T-315

custom glass options

- BC4 antique black caming
- BC5 antique black caming
- BS1 clear glass

Barrington Sierra & Flagstaff unique features

- beautiful mahogany texture**
featuring a beige-colored fiberglass facing perfect for a Southwest, Spanish or Mediterranean look
- custom panel profile**
reproduces artisan construction
- subtle details in flagstaff**
incorporates elements of contemporary styling, while staying rooted in traditional cottage and rustic themes
- select designs are also available with AvantGuard™ Spanish Cedar or Black Walnut finishes



LIFETIME LIMITED WARRANTY
See pages 18-20 for full door details.

Barrington® Sierra™ & Flagstaff™ fiberglass door series

plank feature	6'8" 3'0"	8'0" 3'0", 3'6"	6'8" 3'0"	8'0" 3'0", 3'6"	6'8" 3'0"	8'0" 3'0", 3'6"	6'8" 3'0"	8'0" 3'0", 3'6"	6'8" 1'0", 1'2"	8'0" 1'0", 1'2"	6'8" 1'0", 1'2"	8'0" 1'0", 1'2"
no plank	BSN	–	BSN	–	BSN	–	BSN	–	BR1	BR2	BR3	BS1
plank	BSP	plank	BSP	plank	BSP	plank	BSP	plank	–	–	–	–
plank	–	–	–	–	–	–	–	–	–	antique black	platinum	clear glass

- BAR Barrington® Oak Textured
- BRM Barrington® Mahogany Textured
- BRC Barrington® Craftsman Oak Textured
- BCM Barrington® Craftsman Mahogany Textured
- BSN Barrington® Sierra™ No Plank
- BSP Barrington® Sierra™ Plank
- BFS Barrington® Flagstaff™ Plank

entry configuration options



fiberglass

selection & style

- BLT Belleville® Oak Textured
- BMT Belleville® Mahogany Textured
- BLS Belleville® Smooth
- OAK Oakcraft®



Belleville 6 panel camber-top features a custom shaker panel profile for additional architectural interest.

Specialty™ glass inserts
 Premium decorative glass inserts feature a triple-pane insulated glass assembly.
 Clear and etched glass inserts feature double-pane insulated glass. Flush-glazed designs are also available.

137-3228

Belleville Textured unique features

- oak or mahogany variable-depth wood-grain texture** creates authentic hardwood appearance that finishes easily and beautifully
- high-performance fiberglass** provides maximum protection and durability that will not dent or rust and resists splitting, cracking and warping
- high-definition panel profile** creates excellent shadow lines and distinct panel designs
- engineered hinge and lock stiles** feature laminated lumber which provides excellent dimensional stability
- internal blocking** in lock area provides reinforcement and solid mounting surface for hardware
- true square-edge design** offers an authentic wood door appearance and permits easy field machining
- composite bottom rail** creates a rot and moisture resistant structure

LIFETIME LIMITED WARRANTY
 See page 22 for full door details.

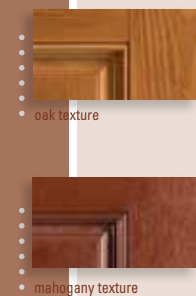

accentuating personal style

Belleville® Oak Textured & Mahogany Textured fiberglass door series

Height	BLT FLUSH	BLT 1/4" ARCH	BLT 1/2" SQUARE	BLT 3/4" ARCH-TOP	BLT 1" BLANK-TOP	BLT 1 1/4" NEW ENGLAND	BLT 1 1/2" BLANK-TOP	BLT 1 3/4" CAMBER-TOP*	BLT 1 7/8" PARLAMENT	BLT SIDEITE with full glass	BLT SIDEITE with 3/4 glass	BLT SIDEITE with 1/2 glass	BMT 1/2" HOULSTER™	BMT 6" P	BMT SIDEITE with full glass	BMT SIDEITE with 3/4 glass	BMT SIDEITE with 1/2 glass	
6'8"	2'0", 2'6", 2'8" 2'10", 3'0"	2'8", 2'10" 3'0"	2'8", 2'10" 3'0"	2'8", 2'10" 3'0"	2'8", 2'10" 3'0"	2'8", 2'10" 3'0"	2'8", 2'10" 3'0"	2'6", 2'8" 2'10", 3'0"	2'8", 2'10" 3'0"	2'10", 3'0"	1'0", 1'2"	1'0", 1'2"	2'8", 2'10", 3'0"	2'8", 2'10", 3'0"	1'0", 1'2"	1'0", 1'2"	1'0", 1'2"	
7'0"	2'0", 2'6", 2'8" 2'10", 3'0"	-	-	-	-	-	-	2'8", 2'10" 3'0"	-	-	1'0", 1'2"	-	-	-	-	-	-	
8'0"	2'0", 2'6", 2'8" 2'10", 3'0"	-	2'8", 2'10" 3'0"	-	-	-	-	2'6", 2'8" 2'10", 3'0"	-	2'10", 3'0"	1'0", 1'2"	1'0", 1'2"	2'8" 2'10", 3'0"	2'8", 2'10", 3'0" 3'6"	1'0", 1'2"	-	-	
fire door option	2'0", 2'6", 2'8" 2'10", 3'0"	-	2'8", 2'10" 3'0"	-	-	2'8", 2'10" 3'0"	-	2'8", 2'10", 3'0"	-	-	-	-	-	3'0"	-	-	-	
glass sizes	109, 120, 122 300, 810	306	106, 404	304 404, 410	105, 106, 107 135, 137, 228	106	105, 106, 107 135, 137, 228	106, 120, 122 228, 404, 810	137, 228	201, 203	149, 151 152, 852	152, 450	129, 450	122, 304 306, 404	106, 122, 228 404, 810	152, 852	450	129

Oakcraft Textured unique features

- wood-grain texture** yields a wood-like appearance and provides easy finishing
- high-performance fiberglass** provides maximum protection and durability that will not dent or rust and resists splitting, cracking and warping
- engineered hinge and lock stiles** feature laminated lumber which provides excellent dimensional stability
- internal blocking** in lock area provides reinforcement and solid mounting surface for hardware
- true square-edge design** offers an authentic wood door appearance and permits easy field machining
- composite bottom rail** creates a rot and moisture resistant structure

25 YEAR LIMITED WARRANTY
 See page 26 for full door details.



Oakcraft® fiberglass door series

Height	OAK FLUSH	OAK 3/4" ARCH-TOP	OAK 1" BLANK-TOP	OAK 1 1/4" NEW ENGLAND	OAK 1 1/2" EYE-BROW	OAK 1 3/4" EYE-BROW W/ SCROLL	OAK 6" P	OAK 9" P	OAK SIDEITE with full glass	OAK SIDEITE with 3/4 glass	OAK SIDEITE with 1/2 glass
6'8"	2'0", 2'6", 2'8" 2'10", 3'0"	2'8", 2'10" 3'0"	2'8", 2'10" 3'0"	2'6", 2'8" 2'10", 3'0"	2'8", 2'10" 3'0"	2'8", 2'10" 3'0"	2'6", 2'8" 2'10", 3'0"	2'8", 2'10" 3'0"	10", 1'0", 1'2"	1'0", 1'2"	1'0", 1'2"
7'0"	2'0", 2'6", 2'8" 2'10", 3'0"	-	-	2'6", 2'8" 2'10", 3'0"	-	-	-	-	10", 1'0", 1'2"	-	1'0", 1'2"
8'0"	2'0", 2'6", 2'8" 2'10", 3'0"	-	-	-	-	-	2'6", 2'8" 2'10", 3'0"	-	10", 1'0", 1'2"	-	1'0", 1'2"
fire door option	2'0", 2'6", 2'8" 2'10", 3'0"	-	-	2'8", 2'10" 3'0"	-	2'8", 2'10" 3'0"	2'8", 2'10" 3'0"	-	-	-	-
glass sizes	109, 120, 122 300, 810	304 404, 410	105, 106, 107 135, 137, 228	106	106, 107	106, 107	106, 120, 122 228, 404	136	149, 151 152, 852	450	129, 450

Belleville® Smooth fiberglass door series

Height	BLS FLUSH	BLS 1/2" SQUARE	BLS 3/4" ARCH-TOP	BLS 1" BLANK-TOP	BLS 1 1/4" NEW ENGLAND	BLS 1 1/2" BLANK-TOP	BLS 1 3/4" CAMBER-TOP*	BLS 1 7/8" PARLAMENT	BLS SIDEITE with full glass	BLS SIDEITE with 3/4 glass	BLS SIDEITE with 1/2 glass
6'8"	2'0", 2'6", 2'8" 2'10", 3'0"	2'8", 2'10" 3'0"	2'8", 2'10" 3'0"	2'8", 2'10" 3'0"	2'8", 2'10" 3'0"	2'8", 2'10" 3'0"	2'6", 2'8" 2'10", 3'0"	2'8", 2'10" 3'0"	2'10", 3'0"	10", 1'0", 1'2"	1'0", 1'2"
7'0"	2'0", 2'6", 2'8" 2'10", 3'0"	-	-	-	-	-	2'8", 2'10" 3'0"	-	-	10", 1'0", 1'2"	-
8'0"	2'0", 2'6", 2'8" 2'10", 3'0"	2'8", 2'10" 3'0"	-	-	-	-	2'6", 2'8" 2'10", 3'0"	-	2'10", 3'0"	-	1'0", 1'2"
fire door option	2'0", 2'6", 2'8" 2'10", 3'0"	2'8", 2'10" 3'0"	-	-	2'8", 2'10" 3'0"	-	2'8", 2'10" 3'0"	-	-	-	-
glass sizes	109, 120, 122 300, 810	106, 404	304 404, 410	105, 106, 107 135, 137, 228	106	105, 106, 107 135, 137, 228	106, 120, 122 228, 404, 810	137, 228	201, 203	149, 151 152, 852	152, 450

† Features narrow panel layout. * 6 panel Camber-top features a straight-grain hardwood texture.
 Available as 20-minute Warnock-Hershey® listed fire door (features an engineered solid core). Fire door option only available for 6'8" and 7'0" doors.



OAKCRAFT™ with Sierra™ glass OAK-404-817-2

BELLEVILLE™ HOULSTER™ MAHOGANY TEXTURED with Aspen™ glass BMT-304-336-2

BELLEVILLE™ OAK TEXTURED with Quartz™ glass BLT-106-957-1

BELLEVILLE™ SMOOTH with Eminent™ glass BLS-137-3228-3

BELLEVILLE®
 Fiberglass Entry Doors

Oakcraft®
 Wood-grain Textured
 FIBERGLASS ENTRY DOORS

staining textured wood-grain doors

Staining your fiberglass entry system has never been easier. The fiberglass staining kit from Masonite comes with everything you need to achieve a high-quality finish.



complete stain kit

- ZAR® exterior water-based polyurethane (Qt.)
- ZAR wood stain (Pt.)
- mineral spirits (4 oz.)
- one synthetic bristle brush (2-1/2")
- two foam brushes (2")
- two stir sticks
- one pair of latex gloves
- cheese cloths
- door staining instructions



Stain colors are approximate and may vary in actuality to printed materials.

Masonite Tested

Masonite has tested many competing stain and topcoat systems for ease of application, finish quality, and durability and highly recommends the ZAR system.

Conveniently Packaged

For your convenience we have pre-packaged all the supplies you need to finish your Barrington, Belleville, or Oakcraft door into one convenient kit.

Beautiful Finish

Choose from six distinct colors and customize the shade of your door from light to dark to suit your needs. Finish the project by applying the UV resistant clear satin polyurethane for years of protection and beauty.



MASONITE® FIBERGLASS DOOR FINISHING KIT

MASONITE® SPECIALTY™ GLASS AVAILABILITY CHARTS

glass shape options for doors displayed

Door Style	Code	Option 1	Option 2	Option 3	Option 4	Option 5
flush	BLT BLS OAK SHD MHD	109	120	122	300	810
1 panel arch	BLT SHD MHD	306				
2 panel square-top	BLT BLS	106	404			
2 panel camber-top	MHD	106	107			
2 panel camber-top plank	MHD	106	107			
2 panel Hollister™	BMT	304	404	306	122	
3 panel arch-top	BLT BLS OAK SHD MHD	304	404	410	122	
4 panel blank-top	BLT BLS OAK SHD MHD	105	106	107	135	137
4 panel New England	BLT BLS OAK SHD MHD	106				
6 panel blank-top	BLT BLS	105	106	107	135	137
6 panel	BLT BMT BLS OAK SHD MHD	106	120	122	228	404
6 panel camber-top	BLT BLS	137	228			
8 panel parliament	BLT BLS SHD MHD	203	201			
9 panel	OAK SHD MHD	136				

specialty glass selection & style

FEATURES

1 Quality Supported by Old Style Craftsmanship

✓ designs that enhance the appearance and value of your home without compromising security or privacy

2 Glass Style Selection

✓ welcoming new designs; Quattro™, Sienna™ and Element™ to our already large selection

3 Wide Range of Glass Sizes

✓ pick out your favorite door and select the glass that reflects the impression you desire for your front entrance

4 Caming Types

✓ caming choices available to match your style

5 Insulated Triple-Pane Glass inserts

✓ premium decorative glass features
1" insulated triple-pane glass inserts

6 Centurion® Frames

✓ Centurion frames won't discolor in UV exposure and remain stable in high-heat applications. For applications not requiring a Centurion frame, we offer our paintable, stainable frame in almond or terra cotta on select frames

7 Seal-rite™ Corner Screws

✓ the majority of our frames feature Seal-rite corner screws, which provide added resistance to the elements and are easier to assemble



- BLT Belleville® Oak Textured
- BMT Belleville® Mahogany Textured
- BLS Belleville® Smooth
- OAK Oakcraft®
- SHD Sta-Tru® HD Steel
- MHD Masonite® HD Steel

www.masonite.com

www.masonite.com

inspired by people

designed with precision

MASONITE. THE BEAUTIFUL DOOR.®

At Masonite, we remain relentlessly committed to delivering product, service and design innovations that enhance beauty and functionality. These innovations create greater value for our customers throughout the world – innovations that will make your home more beautiful.

Our leadership and superior products have earned us a reputation that is unsurpassed in the industry.

So, when it comes to quality, innovation, value, design and beauty, you can confidently put your trust in Masonite. The Beautiful Door.®

BELLEVILLE® HOLLISTER™ MANOJANY™ TEXTURED with Element™ glass (P&T 404-326-1)



BARRINGTON™ DAKOTA™ with AwardGuard™ Spanish Cedar finish (P&T 404-326-2)



BARRINGTON™ SERRA™ 2 panel (center top with AwardGuard™ Black Walnut finish (P&T 404-326-3)



www.masonite.com



BARRINGTON® HOLLISTER™ with American® Best Wood®

BARRINGTON® HOLLISTER™ with American® Best Wood®

BARRINGTON® HOLLISTER™ with American® Best Wood®

BARRINGTON® HOLLISTER™ with American® Best Wood®

100 STEEL 2-panel center-top glass

BARRINGTON® HOLLISTER™ with American® Best Wood®

BARRINGTON® SIERRA™ with AvantGuard Spanish Cedar™ finish

BELLEVILLE® HOLLISTER™ MAHOGANY TEXTURED with Quattro™ glass

Masonite's Commitment

At Masonite, employees from all parts of the Company – sales, marketing, research and development, customer service and manufacturing – understand that people love their homes. In the past, homes were purchased to meet functional needs. Today, homes are purchased to meet specific lifestyles and to satisfy the need to create multiple living environments within a single home. To meet these lifestyle needs, Masonite is continually creating new and innovative products that will make every home more beautiful, more valuable and more enjoyable. With the ultimate goal of adding beauty and value to every home, Masonite's products are designed and constructed to exacting standards and specifications. All materials – wood, fiberglass, steel or composites – are engineered and carefully selected to ensure lasting durability and performance. For individuals who are building, renovating or redecorating, Masonite products are certain to beautify and accentuate a wide array of architectural home styles.



Masonite®, "Masonite. The Beautiful Door.," AvantGuard®, Barrington®, Belleville®, Flagstaff®, Hollister®, Oakcraft®, Sierra™, Sta-Tru®, Speciality®, Alston®, Aurora®, Chandler®, Element®, Fundy®, Georgian®, Gloce®, Madrid®, Merquise®, Monaco®, Naples®, Newark®, Oxford®, Panama®, Quattro®, Riviera®, Rockland®, Sierra®, Victorian®, Woodbridge™ and Zavalla®, Centurion®, Seal-rite™ and Fast-Frame™ are trademarks of Masonite International Corporation. Please check with your Masonite dealer or distributor for current warranty terms and conditions. Our continuing program of product improvement makes specification, design and product detail subject to change without notice.
860077 4/09 PRINTED IN THE USA ©2009 by Masonite International Corporation

